

General Warranty

We warrant that the product will be free from defects in materials and workmanship for a period of 3 years from the date of purchase of the product by the original purchaser from the our company. The warranty period for accessories such as probes is 12 months. This warranty only applies to the original purchaser and is not transferable to a third party.

If the product proves defective during the warranty period, we will either repair the defective product without charge for parts and labour, or will provide a replacement in exchange for the defective product. Parts, modules and replacement products used by our company for warranty work may be new or reconditioned like new. All replaced parts, modules and products become the property of our company.

To obtain service under this warranty, the customer must notify our company of the defect before the expiration of the warranty period. Customer shall be responsible for packaging and shipping the defective product to designated service centre, a copy of the customer's proof of purchase is also required.

This warranty shall not apply to any defect, failure or damage caused by improper use or improper or inadequate maintenance and care. We shall not be obligated to furnish service under this warranty a) to repair damage resulting from attempts by personnel other than our company representatives to install, repair or service the product; b) to repair damage resulting from improper use or connection to incompatible equipment; c) to repair any damage or malfunction caused by the use of non our supplies; or d) to service a product that has been modified or integrated with other products when the effect of such modification or integration increases the time or difficulty of servicing the product.

Please contact the nearest Sales and Service Offices for services.

Excepting the after-sales services provided in this summary or the applicable warranty statements, we will not offer any guarantee for maintenance definitely declared or hinted, including but not limited to the implied guarantee for marketability and special-purpose acceptability. We should not take any responsibilities for any indirect, special or consequent damages.

Table of Contents

1. General Safety Requirements	1
2. Safety Terms and Symbols	2
3. Quick Start	4
Introduction to the Structure of the Oscilloscope	4
Front Panel	4
Rear Panel	5
Control Area	6
User Interface Introduction	7
How to Implement the General Inspection	8
How to Implement the Function Inspection	9
How to Implement the Probe Compensation	10
How to Set the Probe Attenuation Coefficient	11
How to Use the Probe Safely	12
How to Implement Self-calibration	12
Introduction to the Vertical System	12
Introduction to the Horizontal System	14
Introduction to the Trigger System	14
How to Measure Automatically	15
4. Communication with PC	16
5. Appendix	16
Appendix A: Enclosure	16
Appendix B: General Care and Cleaning	17
Appendix C: USB Disk Requirements	18

1. General Safety Requirements

Before use, please read the following safety precautions to avoid any possible bodily injury and to prevent this product or any other connected products from damage. In order to avoid any contingent danger, ensure this product is only used within the range specified.

Only the qualified technicians can implement the maintenance.

To avoid Fire or Personal Injury:

- **Connect the probe correctly. The grounding end of the probe corresponds to the grounding phase. Please don't connect the grounding end to the positive phase.**
- **Use Proper Power Cord.** Use only the power cord supplied with the product and certified to use in your country.
- **Connect or Disconnect Correctly.** When the probe or test lead is connected to a voltage source, please do not connect and disconnect the probe or test lead at random.
- **Product Grounded.** This instrument is grounded through the power cord grounding conductor. To avoid electric shock, the grounding conductor must be grounded. The product must be grounded properly before any connection with its input or output terminal.

When powered by AC power, it is not allowed to measure AC power source directly, because the testing ground and power cord ground conductor are connected together, otherwise, it will cause short circuit.

- **Check all Terminal Ratings.** To avoid fire or shock hazard, check all ratings and markers of this product. Refer to the user's manual for more information about ratings before connecting to the instrument.
- **Do not operate without covers.** Do not operate the instrument with covers or panels removed.
- **Use Proper Fuse.** Use only the specified type and rating fuse for this instrument.
- **Avoid exposed circuit.** Do not touch exposed junctions and components when the instrument is powered.
- **Do not operate if in any doubt.** If you suspect damage occurs to the instrument, have it inspected by qualified service personnel before further operations.
- **Use your Oscilloscope in a well-ventilated area.** Make sure the instrument installed with proper ventilation, refer to the user manual for more details.
- **Do not operate in wet conditions.**
- **Do not operate in an explosive atmosphere.**
- **Keep product surfaces clean and dry.**

2. Safety Terms and Symbols

Safety Terms

Terms in this manual. The following terms may appear in this manual:



Warning: Warning indicates the conditions or practices that could result in injury or loss of life.



Caution: Caution indicates the conditions or practices that could result in damage to this product or other property.

Terms on the product. The following terms may appear on this product:

Danger: It indicates an injury or hazard may immediately happen.

Warning: It indicates an injury or hazard may be accessible potentially.

Caution: It indicates a potential damage to the instrument or other property might occur.

Safety Symbols

Symbols on the product. The following symbol may appear on the product:



Hazardous Voltage



Refer to Manual



Protective Earth Terminal



Chassis Ground



Test Ground

To avoid body damage and prevent product and connected equipment damage, carefully read the following safety information before using the test tool. This product can only be used in the specified applications.



Warning:

The two channels of the oscilloscope are not electrically isolated. The channels should adopt a common ground during measuring. To prevent short circuits, the 2 probe grounds must not be connected to 2 different non-isolated DC levels.

The diagram of the oscilloscope ground wire connection:

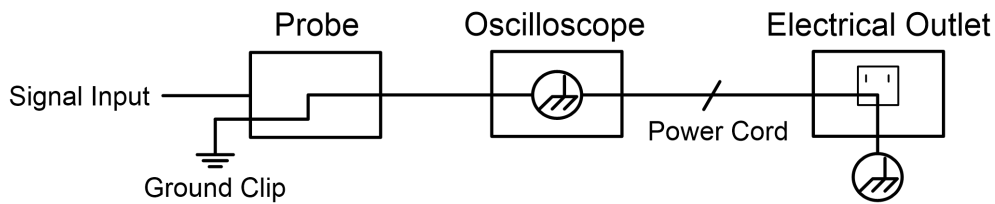

It is not allowed to measure AC power when the AC powered oscilloscope is connected to the AC-powered PC through the ports.



Warning:

To avoid fire or electrical shock, when the oscilloscope input signal connected is more than 42V peak (30Vrms) or on circuits of more than 4800VA, please take note of below items:

- **Only use accessory insulated voltage probes and test lead.**
- **Check the accessories such as probe before use and replace it if there are any damages.**
- **Remove probes, test leads and other accessories immediately after use.**
- **Remove USB cable which connects oscilloscope and computer.**
- **Do not apply input voltages above the rating of the instrument because the probe tip voltage will directly transmit to the oscilloscope. Use with caution when the probe is set as 1:1.**
- **Do not use exposed metal BNC or banana plug connectors.**
- **Do not insert metal objects into connectors.**

※: The illustrations, interface, icons and characters in the user manual may be slightly different from the actual product. Please refer to the actual product.

3. Quick Start

Introduction to the Structure of the Oscilloscope

This chapter makes a simple description of the operation and function of the front panel of the oscilloscope, enabling you to be familiar with the use of the oscilloscope in the shortest time.

Front Panel

The front panel has knobs and function buttons. The 5 buttons in the column on the right side of the display screen are menu selection buttons, through which, you can set the different options for the current menu. The other buttons are function buttons, through which, you can enter different function menus or obtain a specific function application directly.

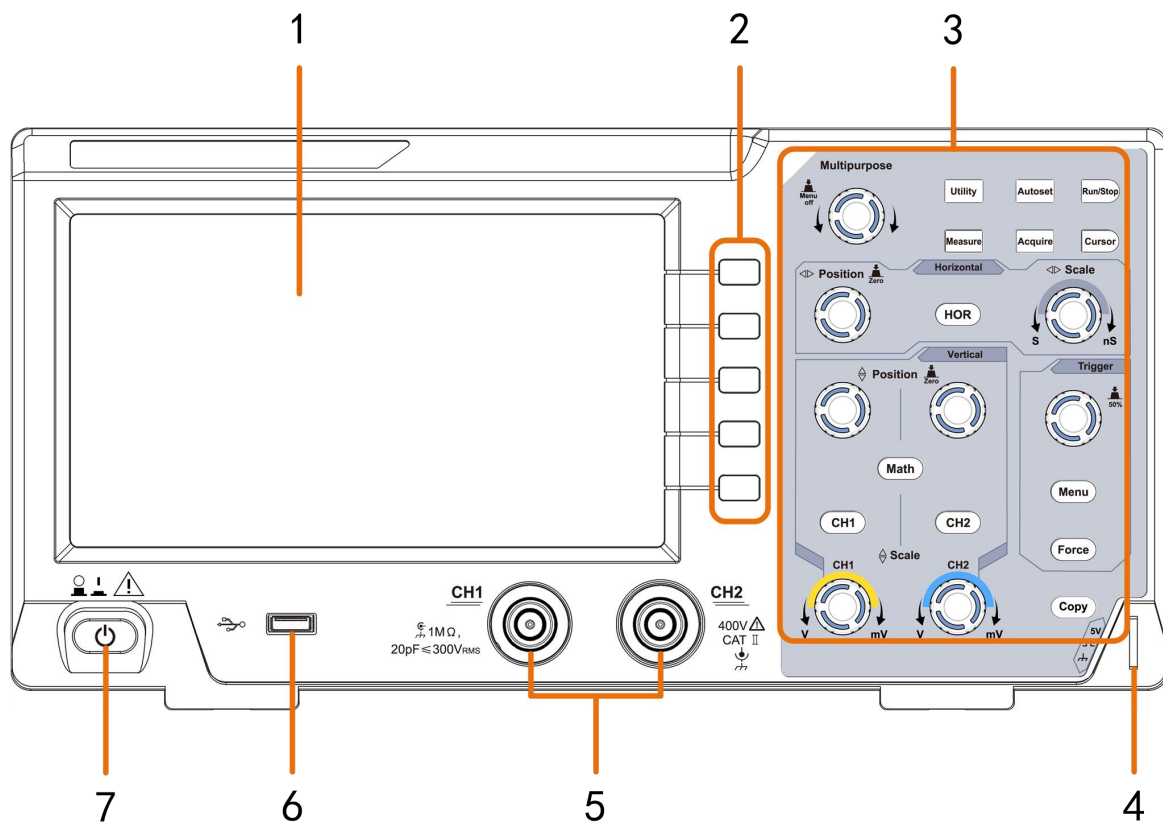

Figure 3- 1 Front panel

1. Display area.
2. Menu selection buttons: Select the right menu item.
3. Control (button and knob) area.
4. Probe Compensation: Measurement signal (5V/1kHz) output.
5. Signal Input Channel.
6. **USB Host port:** It is used to transfer data when external USB equipment connects to the oscilloscope regarded as "host device". For example: Saving the waveform to USB flash disk needs to use this port.
7. Power on/off.

Rear Panel

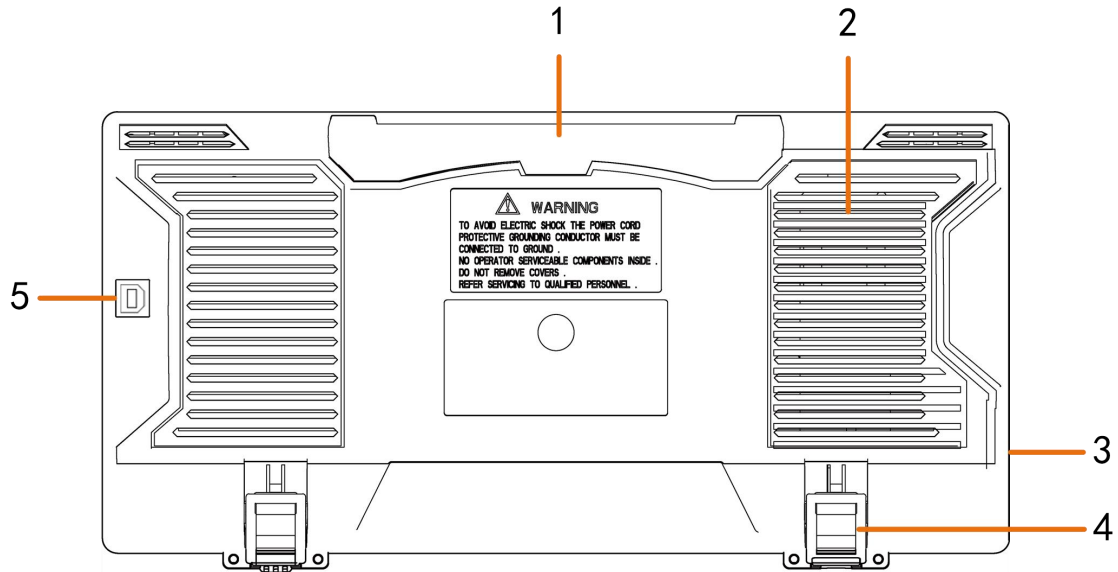

Figure 3-2 Rear Panel

1. Handle.
2. Air vents.
3. AC power input jack.
4. **Foot stool:** Adjust the tilt angle of the oscilloscope.
5. **USB Device port:** It is used to transfer data when external USB equipment connects to the oscilloscope regarded as "slave device". For example: to use this port when connect PC to the oscilloscope by USB.

Control Area

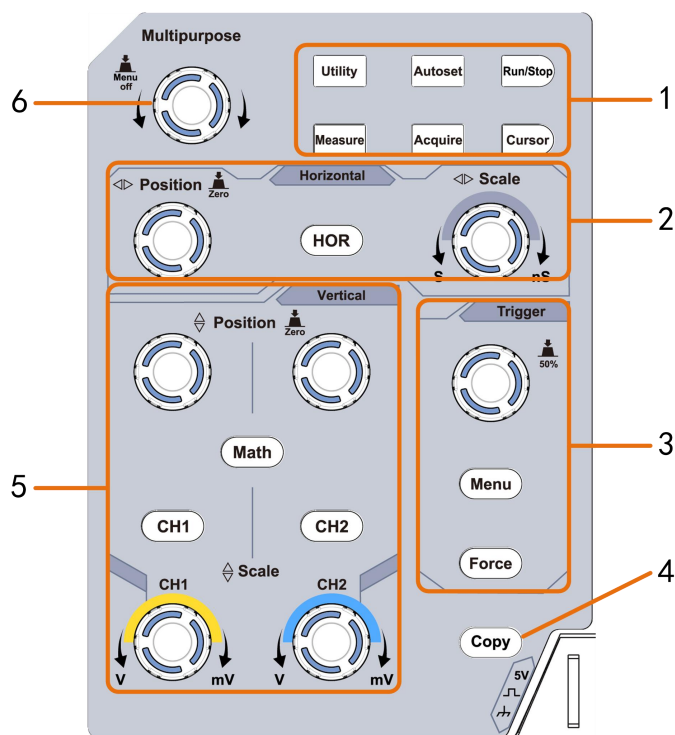

Figure 3-3 Control Area Overview

1. **Function button area:** Total 6 buttons.
2. **Horizontal control area** with 1 button and 2 knobs.
 "HOR" button refer to horizontal system setting menu, "Horizontal Position" knob control trigger position, "Horizontal Scale" control time base.
3. **Trigger control area** with 2 buttons and 1 knob.
 The Trigger Level knob is to adjust trigger voltage. Other 2 buttons refer to trigger system setting.
4. **Copy button:** This button is the shortcut for **Save** function in the **Utility** function menu. Pressing this button is equal to the **Save** option in the Save menu. The waveform, configure or the display screen could be saved according to the chosen type in the Save menu.
5. **Vertical control area** with 3 buttons and 4 knobs.
 "CH1" and "CH2 " correspond to setting menu in CH1 and CH2, "Math" button refer to math menu, the math menu consists of six kinds of operations, including CH1-CH2, CH2-CH1, CH1+CH2, CH1*CH2, CH1/CH2 and FFT. Two "Vertical Position" knob control the vertical position of CH1/CH2, and two "Scale" knob control voltage scale of CH1, CH2.
6. **M knob**(Multipurpose knob): when a **M** symbol appears in the menu, it indicates you can turn the **M** knob to select the menu or set the value. You can push it to close the menu on the left and right.

User Interface Introduction

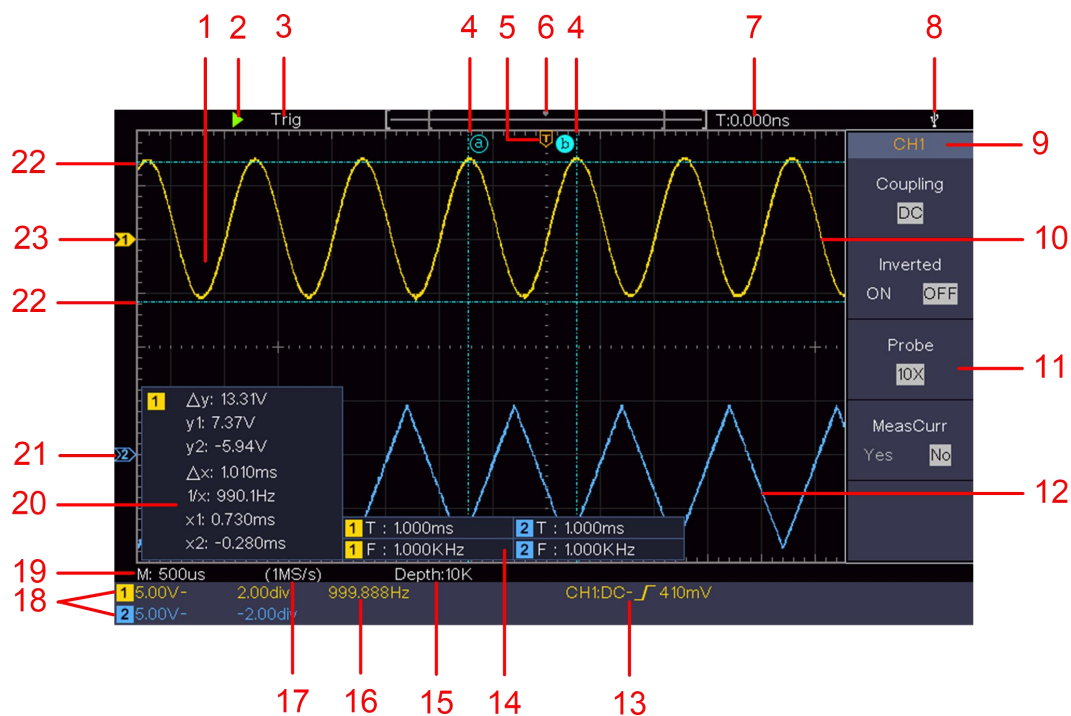





Figure 3-4 Illustrative Drawing of Display Interfaces

1. Waveform Display Area.
2. Run/Stop.
3. The state of trigger, including:
 - Auto: Automatic mode and acquire waveform without triggering.
 - Trig: Trigger detected and acquire waveform.
 - Ready: Pre-triggered data captured and ready for a trigger.
 - Scan: Capture and display the waveform continuously.
 - Stop: Data acquisition stopped.
4. The two blue dotted lines indicates the vertical position of cursor measurement.
5. The T pointer indicates the horizontal position for the trigger.
6. The pointer indicates the trigger position in the record length.
7. It shows present triggering value and displays the site of present window in internal memory.
8. It indicates that there is a USB disk connecting with the oscilloscope.
9. Channel identifier of current menu.
10. The waveform of CH1.
11. Right Menu.
12. The waveform of CH2.
13. Current trigger type:
 - \int Rising edge triggering;

-  Falling edge triggering;
-  Video line synchronous triggering;
-  Video field synchronous triggering.

The reading shows the trigger level value of the corresponding channel.

14. It indicates the measured type and value of the corresponding channel. "T" means period, "F" means frequency, "V" means the average value, "Vp" the peak-peak value, "Vr" the root-mean-square value, "Ma" the maximum amplitude value, "Mi" the minimum amplitude value, "Vt" the Voltage value of the waveform's flat top value, "Vb" the Voltage value of the waveform's flat base, "Va" the amplitude value, "Os" the overshoot value, "Ps" the Preshoot value, "RT" the rise time value, "FT" the fall time value, "PW" the +width value, "NW" the -Width value, "+D" the +Duty value, "-D" the -Duty value, "PD" the Delay A→B Φ value, "ND" the Delay A→B Ψ value, "TR" the Cycle RMS, "CR" the Cursor RMS, "WP" the Screen Duty, "RP" the Phase, "+PC" the +Pulse count, "-PC" the - Pulse count, "+E" the Rise edge count, "-E" the Fall edge count, "AR" the Area, "CA" the Cycle area.
15. The readings show the record length.
16. The frequency of the trigger signal.
17. The readings show current sample rate.
18. The readings indicate the corresponding Voltage Division and the Zero Point positions of the channels. "BW" indicates bandwidth limit.
The icon shows the coupling mode of the channel.
"—" indicates direct current coupling;
"~" indicates AC coupling;
" \equiv " indicates GND coupling.
19. The reading shows the setting of main time base.
20. It is cursor measure window, showing the absolute values and the readings of the cursors.
21. The blue pointer shows the grounding datum point (zero point position) of the waveform of the CH2 channel. If the pointer is not displayed, it means that this channel is not opened.
22. The two blue dotted lines indicate the horizontal position of cursor measurement.
23. The yellow pointer indicates the grounding datum point (zero point position) of the waveform of the CH1 channel. If the pointer is not displayed, it means that the channel is not opened.

How to Implement the General Inspection

After you get a new oscilloscope, it is recommended that you should make a check on the instrument according to the following steps:

1. Check whether there is any damage caused by transportation.

If it is found that the packaging carton or the foamed plastic protection cushion has suffered serious damage, do not throw it away first till the complete device and its accessories succeed in the electrical and mechanical property tests.

2. Check the Accessories

The supplied accessories have been already described in the "Appendix A: Enclosure" of this Manual. You can check whether there is any loss of accessories with reference to this description. If it is found that there is any accessory lost or damaged, please get in touch with the distributor of our responsible for this service or the our local offices.

3. Check the Complete Instrument

If it is found that there is damage to the appearance of the instrument, or the instrument can not work normally, or fails in the performance test, please get in touch with the our distributor responsible for this business or the our local offices. If there is damage to the instrument caused by the transportation, please keep the package. With the transportation department or the our distributor responsible for this business informed about it, a repairing or replacement of the instrument will be arranged by the us.

How to Implement the Function Inspection

Make a fast function check to verify the normal operation of the instrument, according to the following steps:

1. **Connect the power cord to a power source. Press the  button on the bottom left of the instrument.**

The instrument carries out all self-check items and shows the Boot Logo. Push the **Utility** button, select **Function** in the right menu. Select **Adjust** in the left menu, select **Default** in the right menu. The default attenuation coefficient set value of the probe in the menu is 10X.

2. **Set the Switch in the Oscilloscope Probe as 10X and Connect the Oscilloscope with CH1 Channel.**

Align the slot in the probe with the plug in the CH1 connector BNC, and then tighten the probe with rotating it to the right side.

Connect the probe tip and the ground clamp to the connector of the probe compensator.

3. **Push the Autoset Button on the front panel.**

The square wave of 1 KHz frequency and 5V peak-peak value will be displayed in several seconds (see *Figure 3-5*).

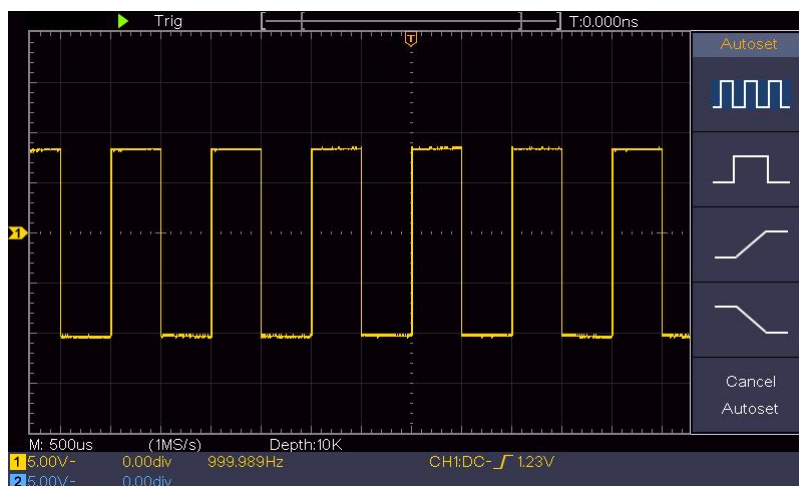

Figure 3-5 Auto set

Check CH2 by repeating Step 2 and Step 3.

How to Implement the Probe Compensation

When connect the probe with any input channel for the first time, make this adjustment to match the probe with the input channel. The probe which is not compensated or presents a compensation deviation will result in the measuring error or mistake. For adjusting the probe compensation, please carry out the following steps:

1. Set the attenuation coefficient of the probe in the menu as 10X and that of the switch in the probe as 10X (see "*How to Set the Probe Attenuation Coefficient*" on P11), and connect the probe with the CH1 channel. If a probe hook tip is used, ensure that it keeps in close touch with the probe. Connect the probe tip with the signal connector of the probe compensator and connect the reference wire clamp with the ground wire connector of the probe connector, and then push the **Autoset** button on the front panel.
2. Check the displayed waveforms and regulate the probe till a correct compensation is achieved (see *Figure 3-6* and *Figure 3-7*).

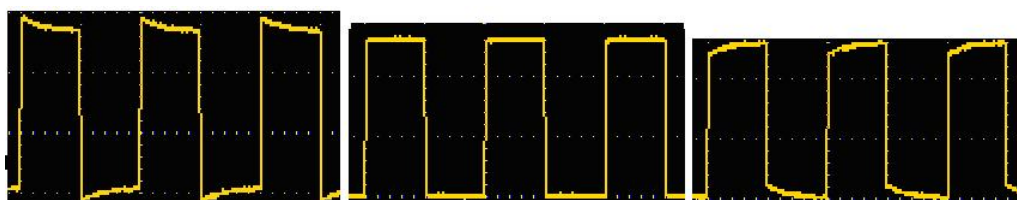

Overcompensated

Compensated correctly

Under compensated

Figure 3-6 Displayed Waveforms of the Probe Compensation

3. Repeat the steps mentioned if needed.

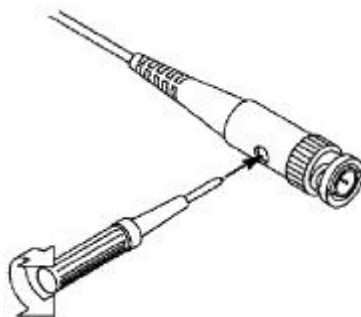

Figure 3-7 Adjust Probe

How to Set the Probe Attenuation Coefficient

The probe has several attenuation coefficients, which will influence the vertical scale factor of the oscilloscope.

To change or check the probe attenuation coefficient in the menu of oscilloscope:

- (1) Push the function menu button of the used channels (**CH1** or **CH2** button).
- (2) Select **Probe** in the right menu; turn the **M** knob to select the proper value in the left menu corresponding to the probe.

This setting will be valid all the time before it is changed again.



Caution:

The default attenuation coefficient of the probe on the instrument is preset to 10X.

Make sure that the set value of the attenuation switch in the probe is the same as the menu selection of the probe attenuation coefficient in the oscilloscope.

The set values of the probe switch are 1X and 10X (see *Figure 3-8*).



Figure 3-8 Attenuation Switch



Caution:

When the attenuation switch is set to 1X, the probe will limit the bandwidth of the oscilloscope in 5MHz. To use the full bandwidth of the oscilloscope, the switch must be set to 10X.

How to Use the Probe Safely

The safety guard ring around the probe body protects your finger against any electric shock, shown as *Figure 3-9*.

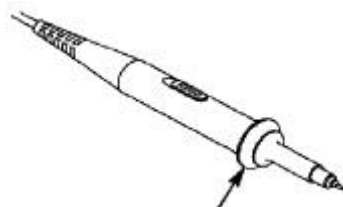

Figure 3-9 Finger Guard



Warning:

To avoid electric shock, always keep your finger behind the safety guard ring of the probe during the operation.

To protect you from suffering from the electric shock, do not touch any metal part of the probe tip when it is connected to the power supply.

Before making any measurements, always connect the probe to the instrument and connect the ground terminal to the earth.

How to Implement Self-calibration

The self-calibration application can make the oscilloscope reach the optimum condition rapidly to obtain the most accurate measurement value. You can carry out this application program at any time. This program must be executed whenever the change of ambient temperature is 5°C or over.

Before performing a self-calibration, disconnect all probes or wires from the input connector. Push the **Utility** button, select **Function** in the right menu, select **Adjust.** in the left menu, select **Self Cal** in the right menu; run the program after everything is ready.

Introduction to the Vertical System

As shown in *Figure 3-10*, there are a few of buttons and knobs in **Vertical Controls**. The following practices will gradually direct you to be familiar with the using of the vertical setting.

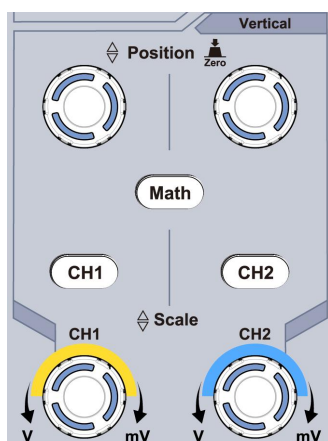

Figure 3- 10 Vertical Control Zone

1. Use the **Vertical Position** knob to show the signal in the center of the waveform window. The **Vertical Position** knob functions the regulating of the vertical display position of the signal. Thus, when the **Vertical Position** knob is rotated, the pointer of the earth datum point of the channel is directed to move up and down following the waveform.

Measuring Skill

If the channel is under the DC coupling mode, you can rapidly measure the DC component of the signal through the observation of the difference between the waveform and the signal ground.

If the channel is under the AC mode, the DC component would be filtered out. This mode helps you display the AC component of the signal with a higher sensitivity.

Vertical offset back to 0 shortcut key

Turn the **Vertical Position** knob to change the vertical display position of channel and push the position knob to set the vertical display position back to 0 as a shortcut key, this is especially helpful when the trace position is far out of the screen and want it to get back to the screen center immediately.

2. Change the Vertical Setting and Observe the Consequent State Information Change.

With the information displayed in the status bar at the bottom of the waveform window, you can determine any changes in the channel vertical scale factor.

- Turn the **Vertical Scale** knob and change the "Vertical Scale Factor (Voltage Division)", it can be found that the scale factor of the channel corresponding to the status bar has been changed accordingly.
- Push buttons of **CH1**, **CH2** and **Math**, the operation menu, symbols, waveforms and scale factor status information of the corresponding channel will be displayed in the screen.

Introduction to the Horizontal System

Shown as *Figure 3-11*, there are a button and two knobs in the **Horizontal Controls**. The following practices will gradually direct you to be familiar with the setting of horizontal time base.

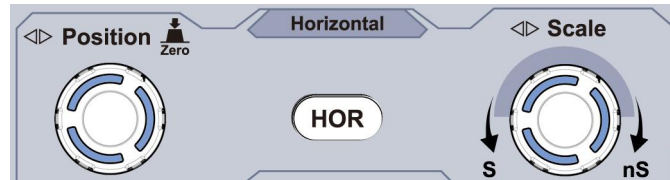

Figure 3- 11 Horizontal Control Zone

1. Turn the **Horizontal Scale** knob to change the horizontal time base setting and observe the consequent status information change. Turn the **Horizontal Scale** knob to change the horizontal time base, and it can be found that the **Horizontal Time Base** display in the status bar changes accordingly.
2. Use the **Horizontal Position** knob to adjust the horizontal position of the signal in the waveform window. The **Horizontal Position** knob is used to control the triggering displacement of the signal or for other special applications. If it is applied to triggering the displacement, it can be observed that the waveform moves horizontally with the knob when you rotate the **Horizontal Position** knob.

Triggering displacement back to 0 shortcut key

Turn the **Horizontal Position** knob to change the horizontal position of channel and push the **Horizontal Position** knob to set the triggering displacement back to 0 as a shortcut key.

3. Push the **Horizontal HOR** button to switch between the normal mode and the wave zoom mode.

Introduction to the Trigger System

As shown in *Figure 3-12*, there are one knob and three buttons make up **Trigger Controls**. The following practices will direct you to be familiar with the setting of the trigger system gradually.

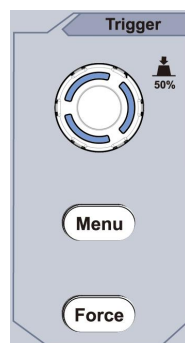

Figure 3- 12 Trigger Control Zone

1. Push the **Trigger Menu** button and call out the trigger menu. With the operations of the menu selection buttons, the trigger setting can be changed.
2. Use the **Trigger Level** knob to change the trigger level setting.
By turning the **Trigger Level** knob, the trigger indicator in the screen will move up and down. With the movement of the trigger indicator, it can be observed that the trigger level value displayed in the screen changes accordingly.
Note: Turning the **Trigger Level** knob can change trigger level value and it is also the hotkey to set trigger level as the vertical mid point values of the amplitude of the trigger signal.
3. Push the **Force** button to force a trigger signal, which is mainly applied to the "Normal" and "Single" trigger modes.

How to Measure Automatically

Push the **Measure** button to display the menu for the settings of the Automatic Measurements. At most 8 types of measurements could be displayed on the bottom left of the screen.

The oscilloscopes provide 30 parameters for auto measurement, including Period, Frequency, Mean, PK-PK, RMS, Max, Min, Top, Base, Amplitude, Overshoot, Preshoot, Rise Time, Fall Time, +PulseWidth, -PulseWidth, +Duty Cycle, -Duty Cycle, Delay A→B Φ , Delay A→B Ψ , Cycle RMS, Cursor RMS, Screen Duty, Phase, +PulseCount, -PulseCount, RiseEdgeCnt, FallEdgeCnt, Area, and Cycle Area.

E.g. Measure the period, the frequency of the CH1, following the steps below:

1. Push the **Measure** button to show the automatic measurement function menu.
2. In the right menu, select **Add CH1**.
3. In the left Type menu, turn the **M** knob to select **Period**.
4. In the right menu, select **Add CH1**. The period type is added.
5. In the left Type menu, turn the **M** knob to select **Frequency**.
6. In the right menu, select **Add CH1**. The frequency type is added.

The measured value will be displayed at the bottom left of the screen automatically.

4. Communication with PC

The oscilloscope supports communications with a PC through USB. You can use the Oscilloscope communication software to store, analyze, display the data and remote control.

For the specific operation method of Oscilloscope host software, please download and view the host help document on our download website.

Here is how to connect with PC via USB port.

- (1) **Set the USB device protocol type of the instrument:** Click Utility → Function → Function → Configure → Device ,switch to PC.
- (2) **Connection:** Use a USB data cable to connect the **USB Device port** in the right panel of the Oscilloscope to the USB port of a PC.
- (3) **Port setting of the software:** Run the Oscilloscope software; click "Communications" on the menu bar, choose "Ports-Settings", in the setting dialog, choose "Connect using" as "USB". After connect successfully, the connection information in the bottom right corner of the software will turn green.

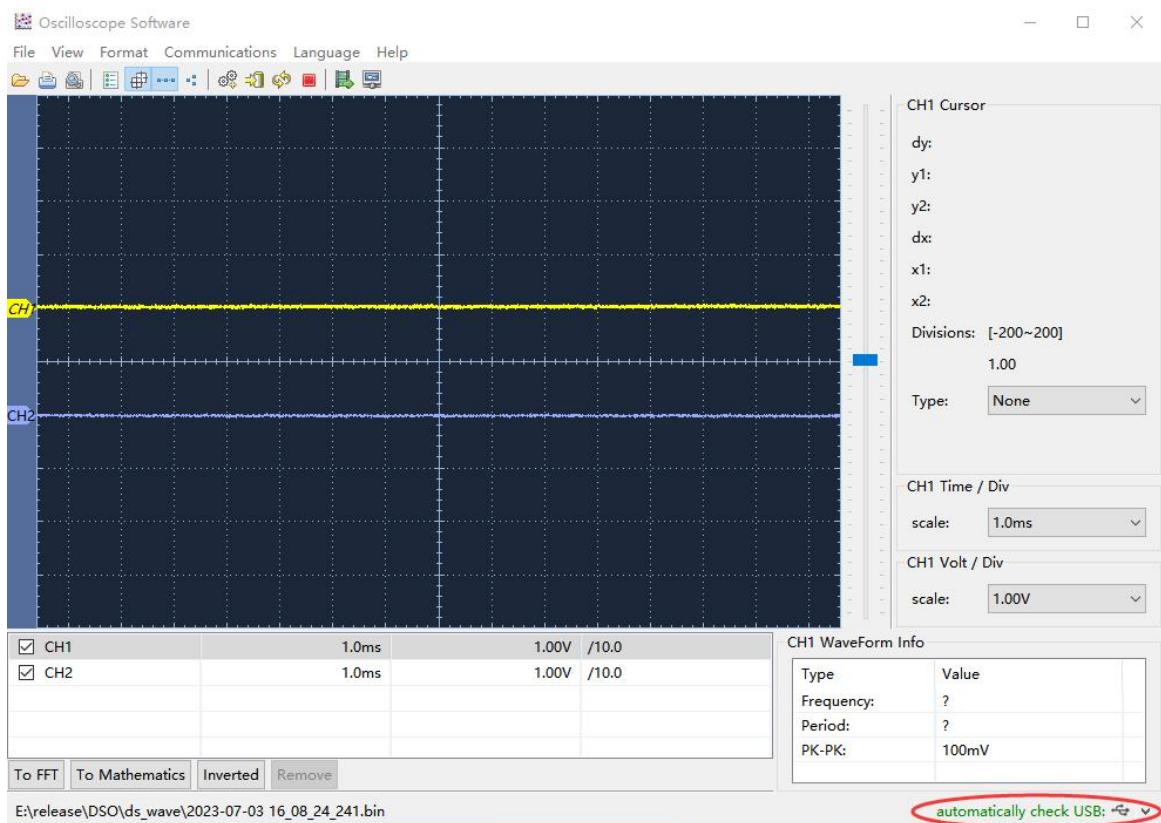

Figure 4- 1 Connect with PC through USB port

5. Appendix

Appendix A: Enclosure

(The accessories subject to final delivery.)

Standard Accessories:



Power Cord



CD Rom



Quick Guide



USB Cable



Probe



Probe Adjust

Options:



Soft Bag

Appendix B: General Care and Cleaning

General Care

Do not store or leave the instrument where the liquid crystal display will be exposed to direct sunlight for long periods of time.

Caution: To avoid any damage to the instrument or probe, do not exposed it to any sprays, liquids, or solvents.

Cleaning

Inspect the instrument and probes as often as operating conditions require.

To clean the instrument exterior, perform the following steps:

1. Wipe the dust from the instrument and probe surface with a soft cloth. Do not make any scuffing on the transparent LCD protection screen when clean the LCD screen.
2. Disconnect power before cleaning your Oscilloscope. Clean the instrument with a wet soft cloth not dripping water. It is recommended to scrub with soft detergent or fresh water. To avoid damage to the instrument or probe, do not use any corrosive chemical cleaning agent.



Warning: Before power on again for operation, it is required to confirm that the instrument has already been dried completely, avoiding any electrical short circuit or bodily injury resulting form the moisture.

Appendix C: USB Disk Requirements

Support USB disk format: USB 2.0 or below, FAT16 or FAT32, allocation unit size no exceed 4k, max capacity 64G. If the USB disk doesn't work properly, format your USB disk and then try again. To learn how to format the USB disk, refer to the User Manual. You can get this manual from the supplied CD or visit www.owon.com.cn.

2023.12 V1.1.2