

# SPD1000X

## Programmable Linear DC Power Supply

User Manual

EN\_03A





# Copyright and Declaration

## Copyright

SIGLENT TECHNOLOGIES CO., LTD. All Right Reserved.

## Trademark Information

**SIGLENT** is a registered trademark of SIGLENT TECHNOLOGIES.

## Declaration

- **SIGLENT** products are protected by patent law in and outside of the People's Republic of China.
- **SIGLENT** reserved the right to modify or change the specifications and price of the product.
- Information in this publication replace all previous corresponding material.
- Any copying, extracting or translation of the content of this manual is not allowed without permission from **SIGLENT**.

## Important Safety Information

This manual contains information and warnings that must be followed by the user for safe operation and to keep the product in a safe condition.

### General Safety Summary

Carefully read the following safety precautions to avoid personal injury and prevent damage to the instrument and any products connected to it. To avoid potential hazards, please use the instrument as specified.

#### **To avoid fire or personal injury, use the proper power cord.**

Only use the state/locally approved power cord with the instrument. Sold to North America and other countries, it will be equipped with power cord meeting local requirements.

	<p><b>WARNING:</b></p> <p>Do not use removable power cords with insufficient ratings.</p>
---	---

#### **Ground the instrument.**

The instrument grounds through the protective terra conductor of the power line. To avoid electric shock, the ground conductor must be connected to the earth. Make sure the instrument is grounded correctly before connect its input or output terminals.

#### **Review all terminal ratings before use.**

To avoid fire or electrical shock, please look over all ratings and instructions for the instrument. Before connecting the instrument, please read the manual carefully to gain more information about the ratings and important use instructions for safe operation.

**Do not operate with suspected failures.**

If you suspect that there is damage to the instrument, halt use and contact your local SIGLENT dealer immediately.

**Do not operate in wet/damp conditions.**







**Do not operate in an explosive atmosphere.**

**Keep the surface of the instrument clean and dry.**

**Anyone operating this equipment should refer to the instruction manual to understand the protection afforded by the equipment. Please use the instrument only in accordance with regulations.**

## Safety Terms and Symbols

When the following symbols or terms appear on the front or rear panel of the instrument or in this manual, they indicate special care in terms of safety.

	This symbol is used where caution is required. Refer to the accompanying information or documents to protect against personal injury or damage to the instrument.
	This symbol warns of a potential risk of shock hazard.
	This symbol is used to denote the measurement ground connection.
	This symbol is used to denote a safety ground connection.
	This symbol shows that do not put electronic equipment as unsorted municipal waste management. Please separate collection or contact equipment suppliers.
	This symbol is used to represent an alternating current, or "AC".
CAUTION	The " <b>CAUTION</b> " symbol indicates a potential hazard. It calls attention to a procedure, practice, or condition which may be dangerous if not followed. Do not proceed until its conditions are fully understood and met.
WARNING	The " <b>WARNING</b> " symbol indicates a potential hazard. It calls attention to a procedure, practice, or condition which, if not followed, could cause bodily injury or death. If a WARNING is indicated, do not proceed until the safety conditions are fully understood and met.

## Working Environment

The design of the instrument has been verified to conform to EN 61010-1 safety standard per the following limits:

### Environment

This instrument is intended for indoor use and should be operated in a clean, dry environment.

### Ambient temperature

Operating: 0 °C to +40 °C

#### Note:

Direct sunlight, radiators, and other nearby heat sources should be taken into account when assessing the ambient temperature.

### Relative Humidity

Operating: 20% to 80% RH, 40 °C, 24 hours

### Altitude

Operating: ≤ 2,000 m

### Overvoltage category

This product is intended to be powered by MAINS that comply with Overvoltage Category II, which is typical of cord-and-plug connected equipment.

#### Note:

Measurement Category II. For measurements performed on circuits directly connected to the low-voltage installation.

Measurement Category III. For measurements performed in the building installation.

Measurement Category IV. For measurements performed at the source of low-voltage installation.

Only mains power supply circuits have an overvoltage category rating.

### Degree of pollution

The Power Supply may be operated in environments of Pollution Degree II.

#### Note:

Degree of Pollution II refers to a working environment that is dry and non-conductive pollution occurs. Occasional temporary conductivity caused by condensation is expected.

	<p>Do not dispose of electronic equipment in unsorted municipal waste. To reduce the impact on the environment, please separate collection processing or contact equipment suppliers.</p>
---	---

### IP rating

IP20 (as defined in IEC 60529).



## Cooling requirements

This instrument relies on forced air cooling with internal fans and ventilation openings. Care must be taken to avoid restricting the airflow around the apertures (fan holes) at the back of the Power Supply. Please keep good ventilation when using, and regularly check the vents and fans.

- 1) Instructions not to position the equipment so that it is difficult to operate the disconnecting device

	<p><b>WARNING:</b></p> <p>Do not block the ventilation holes located on the back of the Power Supply.</p> <p>Do not allow any foreign matter to enter the Power Supply through the ventilation holes, etc.</p> <p>No other objects are allowed 10cm behind the machine to ensure heat dissipation and easy operation of the disconnecting device.</p>
---	---

## AC Power and ground connections

The instrument operates with a single-phase, 100/120/220/230 Vrms  $\pm$  10% AC power at 50 or 60 Hz

The fuse types: 100/120 Vrms  $\pm$  10%: T6.3A 250V

220/230 Vrms  $\pm$  10%: T3.15A 250V

Make sure to use the correct type of fuse before turning on the instrument.

Users must make sure the range of working voltage (100/120/220/230 Vrms  $\pm$  10%) and adjust the dial switch at the back of the machine.

Do not connect the power cord when replacing the fuse.

Find and fix the root cause of fuse damage before replacing the fuse.

The instrument is grounded through the protective terra/Earth conductor of the power cord. To avoid electric shock, the grounding conductor must be connected to the earth. Make sure that the instrument is properly grounded before activating any inputs or outputs.

## Cleaning

Clean only the exterior of the instrument, using a damp, soft cloth. Do not use chemicals or abrasive elements. Under no circumstances should you allow moisture to penetrate the instrument. To avoid electrical shock, unplug the power cord from the AC outlet before cleaning.

	<p><b>WARNING:</b></p> <p>Electrical Shock Hazard!</p> <p>No operator serviceable parts inside. Do not remove covers.</p> <p>Refer servicing to qualified personnel</p>
---	---

## Abnormal conditions

Only operate the instrument for the purposes specified by the manufacturer.

Do not operate the Power Supply if there are any visible signs of damage or if it has been subjected to severe transport stresses.

If you suspect the Power Supply's protection has been impaired, disconnect the power cord, and secure the instrument against any unintended operation.

Proper use of the instrument requires reading and understanding all of the instructions and labels.

If the equipment is used in a manner not specified by the manufacturer, the protection provided by the equipment may be impaired.

	<p><b>WARNING:</b></p> <p>Any use of the Power Supply in a manner not specified by the manufacturer may impair the instrument's safety protection.</p>
---	--

## Informations essentielles sur la sécurité

Ce manuel contient des informations et des avertissements que les utilisateurs doivent suivre pour assurer la sécurité des opérations et maintenir les produits en sécurité.

### Exigence de Sécurité

Lisez attentivement les précautions de sécurité ci - après afin d'éviter les dommages corporels et de prévenir les dommages aux instruments et aux produits associés. Pour éviter les risques potentiels, utilisez les instruments prescrits.

**Éviter l'incendie ou les lésions corporelles.**

**Utilisez une ligne d'alimentation appropriée.**

Seules les lignes d'alimentation en électricité réservées à l'usage exclusif d'instruments reconnus au niveau local peuvent être utilisées. Vendue en Amérique du Nord et dans d'autres pays, elle sera équipée de lignes électriques répondant aux exigences locales.

	<p><b>WARNING:</b></p> <p>N'utilisez pas de cordon d'alimentation amovible de faible puissance.</p>
---	---

**Posez vos instruments par terre.**

L'appareil est mis à la Terre par des conducteurs terra protecteurs de lignes électriques. Pour éviter le contact électrique, le fil de masse doit être mis à la terre. Avant de connecter les bornes d'entrée ou de sortie, assurez - vous que l'instrument est correctement mis à la terre.

**Connectez correctement la ligne de signal.**

Le potentiel de la ligne de signaux est égal à la terre, de sorte que la ligne de signaux ne doit pas être connectée à une haute tension. Ne touchez pas les contacts ou les composants nus.

**Affiche la valeur nominale de toutes les bornes.**

Pour éviter les incendies ou les coupures d'électricité, consultez toutes les valeurs nominales et signez la description de l'instrument. Avant de connecter l'instrument, lisez attentivement le Manuel pour obtenir davantage d'informations sur la valeur nominale.

**Ne pas travailler en cas de panne.**

Si vous soupçonnez que l'appareil est endommagé, demandez au personnel d'entretien qualifié de l'examiner.

**Ne pas fonctionner dans des conditions humides / humides.**







**Pas dans un environnement explosif.**

**Maintenez la surface de l'instrument propre et sec.**

**L'organisme ou l'opérateur responsable doit se référer au cahier des charges pour protéger la protection offerte par le matériel. Veuillez utiliser l'instrument prescrit.**

## Termes et symboles de sécurité

Lorsque les symboles ou termes suivants apparaissent sur le panneau avant ou arrière de l'instrument ou dans ce manuel, ils indiquent un soin particulier en termes de sécurité.

	<p>Ce symbole est utilisé lorsque la prudence est requise. Reportez-vous aux informations ou documents joints afin de vous protéger contre les blessures ou les dommages à l'instrument.</p>
	<p>Ce symbole avertit d'un risque potentiel de choc électrique.</p>
	<p>Ce symbole est utilisé pour désigner la connexion de terre de mesure.</p>
	<p>Ce symbole est utilisé pour indiquer une connexion à la terre de sécurité.</p>
	<p>This symbol shows that do not put electronic equipment as unsorted municipal waste management. Please separate collection or contact equipment suppliers.</p>
	<p>Ce symbole est utilisé pour représenter un courant alternatif, ou "AC".</p>
<p>CAUTION</p>	<p>Le symbole "<b>CAUTION</b>" indique un danger potentiel. Il attire l'attention sur une procédure, une pratique ou une condition qui peut être dangereuse si elle n'est pas suivie. Ne continuez pas tant que ses conditions n'ont pas été entièrement comprises et remplies.</p>
<p>WARNING</p>	<p>Le symbole "<b>WARNING</b>" indique un danger potentiel. Il attire l'attention sur une procédure, une pratique ou une condition qui, si elle n'est pas suivie, pourrait entraîner des blessures corporelles ou la mort. Si un <b>AVERTISSEMENT</b> est indiqué, ne continuez pas tant que les conditions de sécurité ne sont pas entièrement comprises et remplies.</p>

## Environnement de travail

La conception de l'instrument a été certifiée conforme à la norme EN 61010-1, sur la base des valeurs limites suivantes:

### Environnement

Cet instrument est utilisé à l'intérieur des locaux et doit être utilisé dans un environnement propre et sec.

### Température ambiante

En fonctionnement: 0 °C à +40 °C

**Note:** pour évaluer la température de l'environnement, il convient de tenir compte des rayonnements solaires directs, des radiateurs thermiques et d'autres sources de chaleur.

### Humidité

Fonctionnement: 20 à 80% HR, 40 °C, 24 heures

### Altitude

Fonctionnement: ≤ 2000m

### Catégorie d'installation (surtension)

Ce produit est alimenté par une alimentation électrique conforme à l'installation (surtension) Catégorie II.

### Installation (overvoltage) Category Definitions Définition de catégorie d'installation (surtension)

La catégorie II d'installation (surtension) est un niveau de signal applicable aux terminaux de mesure d'équipement reliés au circuit source. Dans ces bornes, des mesures préventives sont prises pour limiter la tension transitoire à un niveau inférieur correspondant.

La catégorie II d'installation (surtension) désigne le niveau local de distribution d'énergie d'un équipement conçu pour accéder à un circuit alternatif (alimentation alternative).

## Degré de pollution

La charge en courant continu peut être utilisée dans un environnement Pollution Degree II.

**Note:** Pollution Degree II signifie que le milieu de travail est sec et qu'il y a une pollution non conductrice. Parfois, la condensation produit une conductivité temporaire.

## IP Rating

IP20 (as defined in IEC 60529).

## Exigences de refroidissement

L'appareil repose sur un ventilateur interne et un ventilateur de ventilation. Attention. Des mesures doivent être prises pour empêcher que le débit d'air ne soit limité autour de l'ouverture (orifice du ventilateur) après une charge en courant continu. Gardez une bonne ventilation lors de l'utilisation et vérifiez régulièrement les ventilateurs et les ventilateurs.

	<p><b>WARNING:</b></p> <p>Ne bloquez pas l'évent derrière la charge.</p> <p>Ne laissez aucune matière étrangère entrer dans la charge, par exemple par un évent.</p> <p>Aucun autre objet n'est autorisé à 10 cm à l'arrière de la machine pour assurer la dissipation de la chaleur et un fonctionnement facile du dispositif de déconnexion.</p>
---	--

## Connexions d'alimentation et de terre

L'instrument fonctionne à 50 ou 60 Hz à l'aide d'une alimentation en courant alternatif monophasée de 100 / 120 / 220 / 230  $\pm$  10% Vrms.

Type de fusible: 100 / 120 Vrms  $\pm$ 10% : T6.3A 250V

220 / 230 Vrms  $\pm$ 10% : T3.15A 250V

Assurez - vous d'utiliser le bon type de fusible avant d'ouvrir l'instrument.

L'utilisateur doit s'assurer de la plage de tension de fonctionnement (100 / 120 / 220 / 230 Vrms) et régler l'interrupteur de cadran à l'arrière de la machine.

Ne branchez pas le cordon d'alimentation lorsque vous remplacez le fusible.

Avant de remplacer le fusible, identifier et réparer la cause profonde des dommages causés au fusible.

L'instrument est mis à la Terre par un conducteur de mise à la terre de protection du cordon d'alimentation.

Pour éviter un choc électrique, le conducteur de mise à la terre doit être mis à la terre. Assurez - vous que l'instrument est correctement mis à la terre avant d'activer toute entrée ou sortie.

## Nettoyage

Nettoyez uniquement l'extérieur de l'instrument à l'aide d'un chiffon doux et humide. N'utilisez pas de produits chimiques ou d'éléments abrasifs. Ne laissez en aucun cas l'humidité pénétrer dans l'instrument. Pour éviter les chocs électriques, débranchez le cordon d'alimentation de la prise secteur avant de le nettoyer.



**WARNING:** risque de choc électrique!

Aucune pièce réparable par l'opérateur à l'intérieur. Ne retirez pas les capots.

Confiez l'entretien à un personnel qualifié



## Conditions anormales

Utilisez l'instrument uniquement aux fins spécifiées par le fabricant.

N'utilisez pas la lunette s'il y a des signes visibles de dommages ou si elle a été soumise à de fortes contraintes de transport.

Si vous soupçonnez des dommages à la protection contre la charge, éteignez le cordon d'alimentation et sécurisez l'équipement afin d'éviter un fonctionnement accidentel.

Une bonne utilisation de l'instrument nécessite la lecture et la compréhension de toutes les instructions et étiquettes.

La protection offerte par le matériel peut être compromise si celui - ci est utilisé de manière non spécifiée par le fabricant.



**WARNING:** L'utilisation de l'énergie de manière non prescrite par le fabricant peut compromettre la sécurité des instruments.

## SPD1000X Brief Introduction

The Siglent SPD1000X Programmable DC Power Supply has a 2.8 inch TFT-LCD screen, programmable output, and real time graphical trending display. The SPD1168X has maximum output values of 16V/ 8A. The SPD1305X has maximum output values of 30V/ 5A. Both models provide remote sensing as well as output short circuit and overload protection. The SPD1000X is suitable for a variety of applications in research and development, production and repair.



SPD1168X



SPD1305X

### Main features:

- Single high-precision programmable output:
  - SPD1168X: 16 V/ 8 A, total power available is 128 W
  - SPD1305X: 30 V/ 5 A, total power available is 150 W
- Compact and easy to use, ideal for bench power supply
- Stable, reliable and low noise:  $\leq 350 \mu\text{Vrms}/ 3 \text{ mVpp}$
- Fast Transient Response Time:  $< 50 \mu\text{s}$
- Maximum resolution of 1 mV, 1 mA with 5-digit voltage and 4-digit current display.
- Timer function sequences preset output values
- High resolution 2.8 inch TFT LCD ( 240\*320 pixels )

- Two output modes: two-wire output and remote sense compensation function (maximum compensation up to 1 V)
- Four input / line voltage selection choices including 100 V, 110 V, 220 V and 230 V to satisfy different requirements
- Intelligent temperature-controlled fan, effectively reduces noise
- Bright, clear graphical interface, with waveform display
- Five internal system parameter save / recall locations, support for data storage space expansion
- Comes with EasyPower PC software. Real-time control via USB, LAN. Supports SCPI command set and LabView driver package to meet the remote control and communication requirements

# Content

<b>Copyright and Declaration .....</b>	<b>1</b>
<b>General Safety Summary .....</b>	<b>2</b>
<b>Safety Terms and Symbols .....</b>	错误!未定义书签。
<b>SPD1000X Brief Introduction .....</b>	<b>16</b>
<b>1. Start Guide .....</b>	<b>20</b>
1.1 General Inspection .....	21
1.2 The Front Panel.....	22
1.3 The Rear Panel .....	25
1.4 Connect Power.....	27
1.5 User Interface.....	29
1.6 Output Inspection .....	31
1.7 Fuse Replacement .....	32
<b>2. Control panel operation .....</b>	<b>33</b>
2.1 Output summary.....	34
2.2 2-wire mode.....	35
2.3 Remote Sense mode .....	36
2.4 Configuration of LAN interface.....	37
2.5 Save and recall.....	39
2.6 Timer .....	42
2.7 Waveform display.....	44
2.8 Version information .....	45
2.9 OCP mode.....	46
2.10 Lock key .....	46
2.11 Upgrade firmware.....	47
<b>3. Remote control.....</b>	<b>49</b>
3.1 Control method.....	49
3.2 Grammar conventions.....	50
3.3 Command Summary .....	51

3.4	Command description .....	52
3.5	Programming examples .....	60
<b>4.</b>	<b>Common troubleshooting .....</b>	<b>74</b>
<b>5.</b>	<b>Service and Support .....</b>	<b>75</b>
5.1	Maintenance summary .....	75
5.2	Contact SIGLENT .....	76

# 1. Start Guide

In this chapter, we introduce the front panel and display interface of the SPD1000X, and also tips for how to check and operate the power supply the first time.

The main content of Chapter 1 includes:

- General Inspection
- The front panel
- The rear panel
- Connecting power
- User interface
- Output Inspection
- Fuse Replacement

## 1.1 General Inspection

Please check the instrument according to the following steps:

### 1. Inspect the shipping container

Keep the shipping container and cushioning material until the contents of the shipment have been completely checked and the instrument has passed both electrical and mechanical tests. The consigner or carrier is responsible for damages to the instrument resulting from shipment. **SIGLENT** will not provide free maintenance or replacement for shipping damages.

### 2. Inspect the instrument

If there is damage, defects, or failures in electrical and mechanical tests of the product, please contact your nearest **SIGLENT** sales representative.

### 3. Check the accessories

Please check the accessories according to the packing list. If the accessories are incomplete or damaged, please contact your **SIGLENT** sales representative.

## 1.2 The Front Panel



### 1. LCD Display

2.8 inch TFT-LCD is used to display system parameter settings, system output state, menu options, prompt messages, etc.

### 2. Knob

When setting parameters, rotate the knob to increase or decrease the value of the digit at the cursor. In the Store Page the knob can be used to quickly move to the desired file.



### 3. Function button and power key

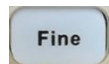

When setting parameters, press the Fine button to move the cursor to select the position of digit to be modified. Press the button longer to enter/exit the OCP editing state.



The left and right direction buttons move the cursor to select the parameter to be modified. Press the left button to move the cursor selection left / upward and press the right button to move the cursor selection right / downward.



Press the button briefly to view the system information screen. Press the button for approximately 1 second or longer to activate the lock function.



Press the button briefly to enter the timer interface. Press the left arrow button to move the cursor left / upward between fields / press the right arrow button to move the cursor right / downward between fields. Press the On/Off button for approximately 1 second or longer to turn on/off the timer. Press the Timer/Wave button for approximately 1 second or longer period to enter the waveform display mode.

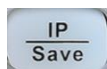

Press the button briefly to configure the network connection information. Then press the left / right buttons to step through the different IP Page addresses and fields. Choose the DHCP field, then press the On/Off button to turn off the IP Setting menu.

Press the IP/Save button for 1 second or longer to enter the storage function system. Press the Fine button to choose the file number location to access, press the Fine button for 1 second or longer to confirm the choice.

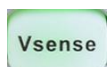

Press the button to enable/disable the remote sense function.

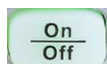

Press the button to enable/disable the channel output.

#### **4. Output Terminal**

Physical output connections to the external circuit.

#### **5. Ground Terminal**

This terminal is connected to the instrument chassis and ground wire, and is at ground potential.

#### **6. Sense terminal**

Used to sense the actual voltage supplied at the load. This allows the source to compensate for any voltage drop caused by the leads between the power supply and the load and increases the accuracy of the voltage delivered to the load. Especially effective when using higher currents and/or longer leads.

#### **7. Power key**

Turns the instrument on or off.

## 1.3 The Rear Panel

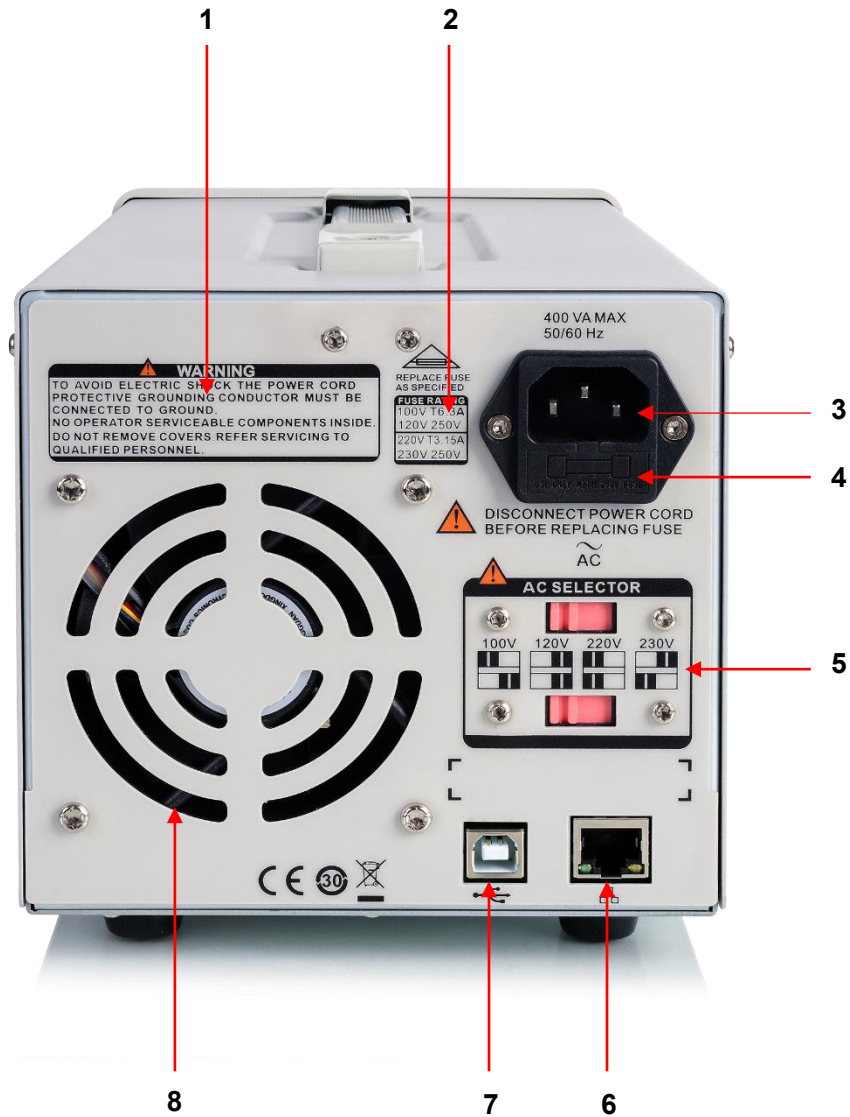

### 1. Warning message

Warning message regarding proper grounding and instrument maintenance.

### 2. AC input voltage description

The frequency, voltage and the specified fuse should correspond to the AC input mains.

### 3. AC power socket

The socket for AC input power.

#### **4. Fuse**

The specified fuse must be rated for the input voltage ( Please refer to the “ **AC input voltage description** ” )

#### **5. AC line power selection switch**

AC Input Voltages: 100V / 120V / 220V / 230 V

#### **6. LAN interface**

RJ45 jack for connection to any user-supplied LAN.

#### **7. USB device**





USB-B connector for connection to a user-supplied USB controller.

#### **8. Fan**

## 1.4 Connect Power

The power supply supports a variety of AC line power input values. For each line voltage, the rear panel voltage selector settings are different, as shown in table 1 below.

Table 1: AC input line power specifications

AC power input	Voltage selector configure
100 VAC $\pm$ 10%, 50 ~ 60 Hz	
120 VAC $\pm$ 10%, 50 ~ 60 Hz	
220 VAC $\pm$ 10%, 50 ~ 60 Hz	
230 VAC $\pm$ 10%, 50 ~ 60 Hz	

Please connect the external AC power carefully using the steps below:

### 1. Check the input power

Make certain that the AC line power to be connected to the instrument meets the requirements outlined in Table 1.

### 2. Check the voltage selector on the rear panel

Make certain that the voltage selector setting on the rear panel of the instrument matches the actual input voltage.

### 3. Check the fuse

When the instrument leaves the factory, the specified fuse is installed. Please check whether the fuse

matches the actual input voltage according to the “ Input Power Requirements ” on the rear panel of the instrument.

#### 4. Connect the power

Connect the instrument to AC power supply using the power cord provided with the accessories. Then press the button  to turn on the power.

**WARNING**

Before switching the input power supply voltage, please disconnect the power supply before setting the voltage selector to the appropriate setting.

**WARNING**

To avoid electric shock, make certain that the instrument is correctly grounded.

## 1.5 User Interface

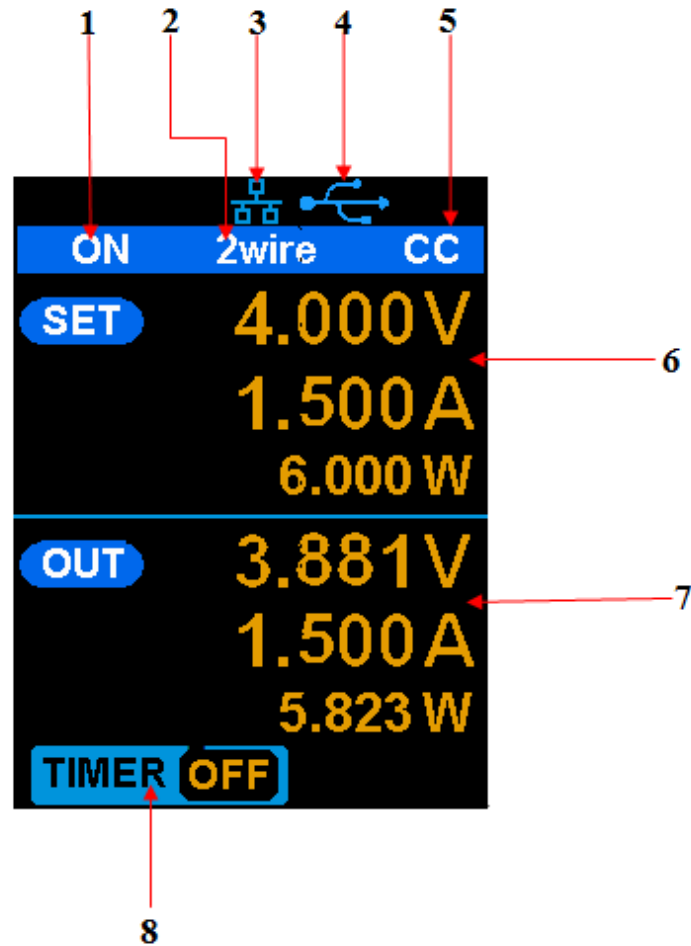

### 1. Channel output state

On / Off

### 2. Remote sense mode

2 wire: two wire mode; 4 wire: four wire (remote sense) mode.

### 3. LAN connection icon

When the instrument is connected to a network through the LAN port this flag is displayed.

#### **4. USB connection icon**

When the instrument is connected to a computer via the USB DEVEICE interface this icon is displayed.

#### **5. Output mode**

CV: Constant Voltage ; CC: Constant Current.

#### **6. Output programmed values**

Voltage, current, power settings

#### **7. Measured output values**

Voltage, current, power actual output

#### **8. Timer state**

On / Off



## 1.6 Output Inspection

### 1. Check the output voltage

- 1) Turn on the power and make certain the channel current setting is not zero when the instrument has no-load.
- 2) Press **on/off** button, the supply should be working in constant voltage (CV) mode. You can check the voltage range of SPD1168X by adjusting the voltage setpoint from the minimum (0 V) to the maximum value (16 V) and the voltage range of SPD1305X by adjusting the voltage setpoint from the minimum (0 V) to the maximum value (30 V).

### 2. Check the output current

- 1) Turn on the power and make certain the voltage setting is not zero.
- 2) Connect the output terminals (short) with an insulated wire that can handle 10 A or more (18 AWG single core, for example).
- 3) Activate the output by pressing the on/off button. The low impedance (shorted) output will cause the instrument to enter current control (CC) mode. You can check the current range of the SPD1168X by adjusting the current setpoint from the minimum (0 A) to the maximum value (8 A) and the current range of the SPD1305X by adjusting the current setpoint from the minimum (0 A) to the maximum value (5 A).

## 1.7 Fuse Replacement

The specifications of the fuse are relative to the actual input line voltage, shown in the table below.

You also can refer to the rear panel “input power requirement”.

Input voltage	Fuse specification
100/ 120 VAC	T6.3A
220/ 230 VAC	T3.15A

To replace the fuse, please follow the steps below:

1. Turn off the instrument and remove the power cord.
2. Insert a small straight screwdriver into the slot at the power socket and gently pry out the fuse seat.

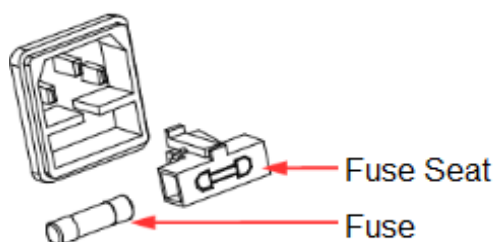

3. Adjust the power voltage selector manually to select the correct voltage scale.
4. Take out the fuse and replace it with the specified fuse (for the corresponding relationship between the AC input voltage and fuse specification, refer to the “input power requirement” at the rear panel).
5. Re-insert the fuse holder into the power socket (please pay attention to the directions).



### WARNING

To avoid personal injuries, unplug the power supply before replacing the fuse. To avoid electric shock or fire, select the proper power supply specification and replace only with the proper fuse.

## 2. Control panel operation

In this chapter, the functions and operation of the SPD1000X control panel will be introduced in detail.

### **Brief introduction:**

- Output summary
- Setting the output voltage and current of the power supply
- Remote terminal
- LAN configuration
- Save/recall
- Timer
- Waveform display
- Version information
- OCP mode
- Lock
- Update

## 2.1 Output summary

- The SPD1000X provides a floating output. The output rating of the SPD1168X is 0-16 V / 0-8 A, while the output rating of SPD1305X is 0-30 V / 0-5 A;
- Two modes of output: constant voltage (CV) and constant current (CC);
- Two types of operation: two wire mode and remote sense mode.

### **Constant voltage output/constant current output:**

In the constant current mode, the output current is a set value which can be controlled by the front panel. The user interface displays the output mode is 'CC' and the current is still in a set value. At this time, the voltage is lower than the set value. When the output current is less than the set value, the constant current mode will switch to constant voltage mode automatically.

In the constant voltage mode, the output current is less than the set value, which can be controlled by the front panel. The user interface displays the output mode is 'CV' and the voltage remains at the set value. When output current reaches the set value, the system switches to the constant current mode.

### **2-wire mode/remote sense mode:**

When the SPD1000X is set to the 2-wire mode, the display prompt displays the working mode as "2-wire". When the output is on, the instrument will detect and display the output terminal's actual output mode automatically.

In the remote sense mode, the prompt displays the working mode as "remote sense". When the output is on and the remote sense terminal connect to the load, the instrument will detect and display the actual output.

## 2.2 2-wire mode

The operation of the output power configuration follows:

### Operation method:

#### 1) Connect the output terminals

As shown in the figure below, connect the load to the output terminals.

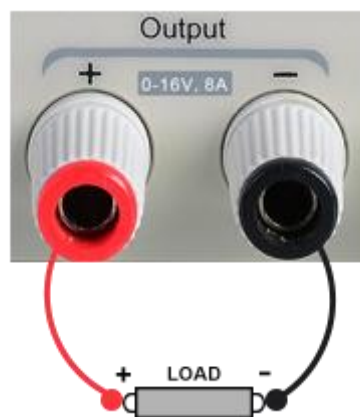

### CAUTION

To avoid damages to the instrument, please pay attention to the positive and negative terminal polarities when connecting.

#### 2) Configure the output of voltage and current

- a) Selecting the parameters to change by moving the left / right arrow keys.
- b) Press **Fine** button to select the data's position, then rotate the knob to change the parameter.

#### 3) Enable the output

Make certain the mode is 2-wire (the **Vsense** key is off and the display shows 2-wire). Press the **On/Off** button, the button light will light up, the channel output is enabled and the display shows the power supply status is "On".

**Note:** Built-in overvoltage protection; When the actual output voltage of the SPD1168X is greater than  $22 \pm 2$  V or the actual output voltage of the SPD1305X is greater than  $36 \pm 2$  V, the output will automatically short-circuit, and limit the voltage output. If this occurs, please re-engage the output enable switch to resume normal output.

## 2.3 Remote Sense mode

When the power supply is outputting a large current, a voltage drop can occur as a result of resistance in the output cable. To ensure an accurate output voltage, the SPD1000X provides a 4-wire (remote sense) mode of operation. In this mode, the voltage at the load terminal is detected instead of the voltage at the power supply output. This allows the instrument to automatically compensate for the voltage drop caused by the load leads, ensuring that the user-specified voltage output matches the voltage delivered to the load. Front panel Sense connections are as shown below.

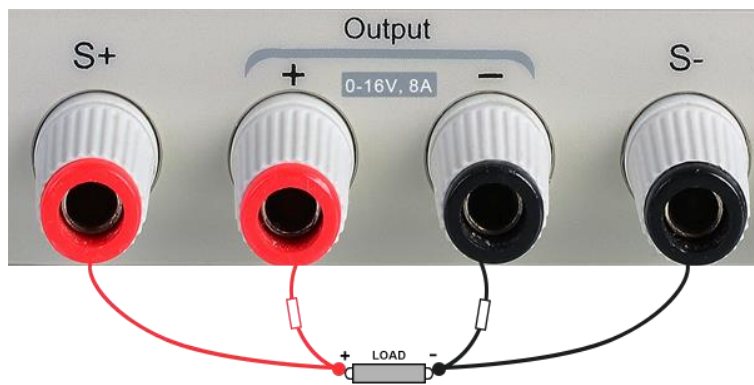

### Operation method:

#### 1. Connect the output terminals and sense terminals

As shown above, connect the front panel output terminal and Sense terminal to both ends of the load.

When connecting, please pay attention to polarity.

## 2. Configure the voltage and current of output

- a) Select the parameters to change by moving the direction of cursor
- b) Press **Fine** button to select the cursor's position, then rotate the knob to adjust the parameter.

## 3. Open the 4-wire mode

Press **Vsense** button, the button will light up. The power supply screen will show '4 wire' on the display.

## 4. Enable the output

Press the **on/off** button, the button light is lit and the power supply display shows "on".

**Note:** In 4-wire mode, the maximum compensation voltage of the power supply is 1 V. When the voltage difference between the output terminal and the Sense terminal is more than 1 V, the instrument will turn off automatically.

## 2.4 Configuration of LAN interface

The SPD1000X supports USB Device and LAN interfaces. You can remotely control the SPD1000X through these interfaces. When using the LAN interface, first set the interface parameters.

### Operation methods:

1. Use the network cable to connect the LAN port on the rear panel with the network where the computer or computers are located.
2. Press **IP/Save** briefly to enter the network setting interface.
3. After setting the IP value, press the multi-function knob or press the **Fine** button for 1 second or longer to make the setting effective, then press the left / right arrow buttons repeatedly to move

the cursor to the DHCP line. Turn the knob to set DHCP to ON or OFF, then press the multi-function knob or press the **On/Off** button briefly to turn on/off the DHCP.

- ON: The power will automatically set the IP address, subnet mask and gateway automatically loaded according to the current access network.
  - OFF: The user can set the IP address, subnet mask and gateway.
    - Press the left/right arrow button to change the position of cursor.
    - Rotate the knob or press the left and right arrow buttons for 1 second or longer to change the data.
    - Press **Fine** button to change the highlighted digit.
    - Press the knob or press the **Fine** button for a longer period to save the setting (all settings will take effect only if the knob is pressed or the **Fine** button is pressed for 1 second or longer).
4. Press **IP/Save** again to exit the network setting interface and return to the main screen.

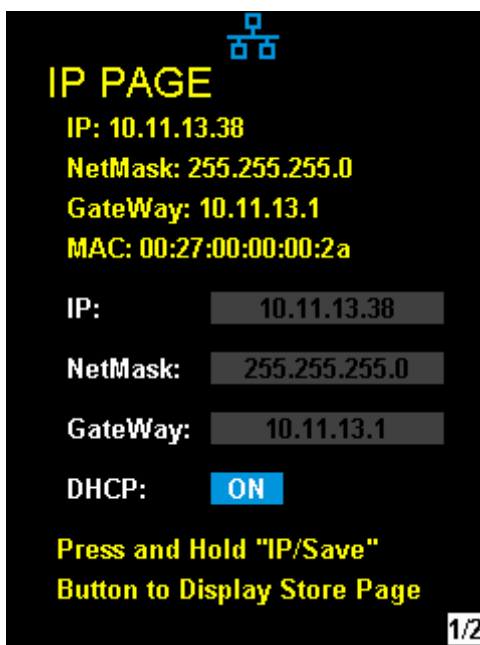



## 2.5 Save and recall

The SPD1000X allows the user to save the current instrument status ( including operating modes, voltage/ current settings, timer parameters, etc.) to the internal memory and recall saved files when required.

- **Save**

### Operation steps:

1. Set the parameter settings to be saved.
2. Press **IP/Save** for 1 second or longer to enter to the Store Page screen.
3. Press the direction button to move the cursor to “ FILE CHOICE ”.
4. Rotate the knob or press the **Fine** button briefly to select the storage location ( FILE 1~ FILE 5 ).
5. Press the arrow buttons to move the cursor to “ OPER CHOICE ”.
6. Turn the multi-function knob to select “STORE” and press the knob or press the **Fine** button for 1 second or longer to select “OK” to save the current settings. After saving, the corresponding file location will turn yellow.

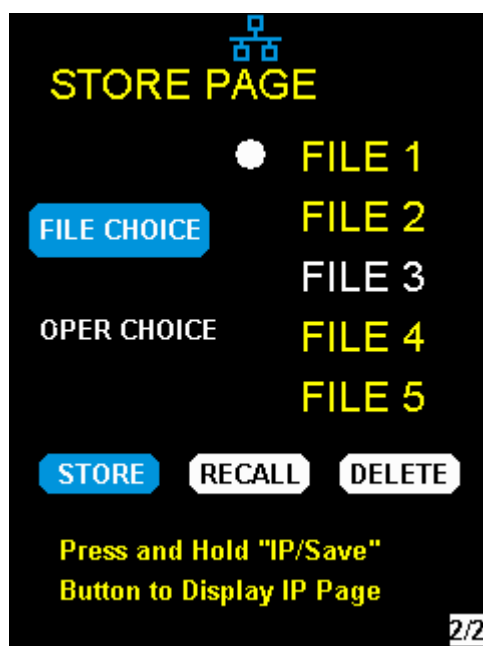

- **Recall**

**Operation steps:**

1. Press **IP/Save** button for 1 second or longer to enter to the Store Page screen.
2. Press the left and right arrow buttons to move the cursor to “ FILE CHOICE ”.
3. Turn the rotary knob or press the **Fine** button briefly to select the instrument status file (FILE 1 ~ FILE 5).
4. Press the arrow buttons to move the cursor to “ OPER CHOICE ”.
5. Turn the multi-function knob to select “RECALL” and press the knob or press the **Fine** button for 1 second or longer to select “OK” to recall the saved file.

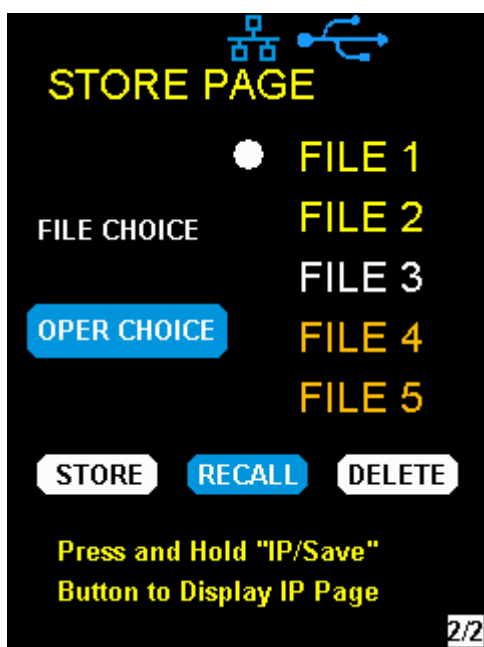

- **Delete**

1. Press **IP/Save** for 1 second or longer to enter the Store Page interface.
2. Press the left and right arrow buttons to move the cursor to “ FILE CHOICE ”.
3. Turn the rotary knob or press the **Fine** button briefly to select the instrument status file ( FILE 1 ~ FILE 5 ).
4. Press the arrow button to move the cursor to “ OPER CHOICE ”.
5. Turn the multi-function knob to select “DELETE” and press the knob or press the **Fine** button

for 1 second or longer to select "OK" to read the saved file.

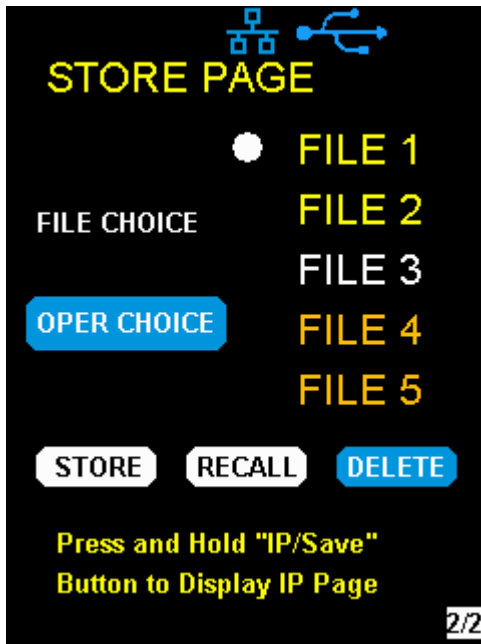

## 2.6 Timer

The SPD1000X provides a timer function. The timer can save five sets of settings, each set independent of the others. The user can set arbitrary parameters within the voltage, current, and dwell time values. The timer supports continuous output, with the longest time-out time of up to 10000 s.

- **Set the timer parameter**

### Operation steps:

1. Press **Timer/Wave** to enter the Timer Setup interface, and the indicator will illuminate.
2. Pressing the arrow keys, move the cursor to select the desired parameter (voltage/ current/ time).
3. Rotate the multi-function knob or press the left and right buttons for 1 second or longer period to set the corresponding value. The **Fine** button can be used to move between the digits in any highlighted field.
4. Press **Timer/Wave** again to exit the Timer interface.

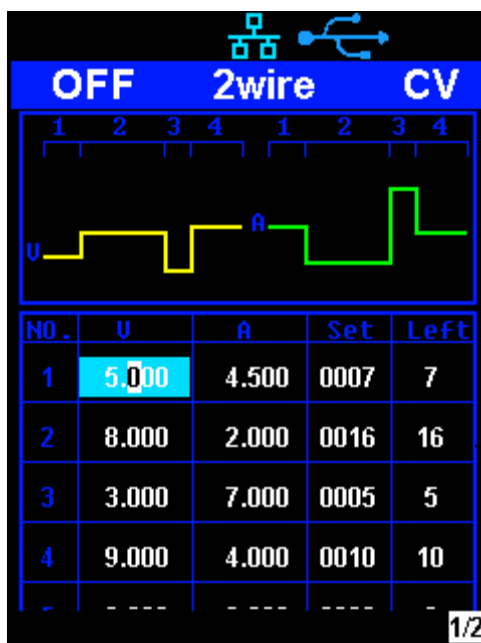

- **Start the Timer**

**Method 1:**

1. Using the arrow keys, move cursor to Timer at the bottom of the screen in the Timer interface screen.
2. Rotate the multi-function knob to turn the Timer state to “ON”.
3. Press the knob to start the Timer. Notice the countdown shown to the right of the Timer On/ Off indicator. It will begin to count down for each segment of the timer profile.
4. Rotate the multi-function knob to turn the Timer state to “OFF”
5. Or press the **On/Off** button for 1 second or longer to turn on/off the Timer.

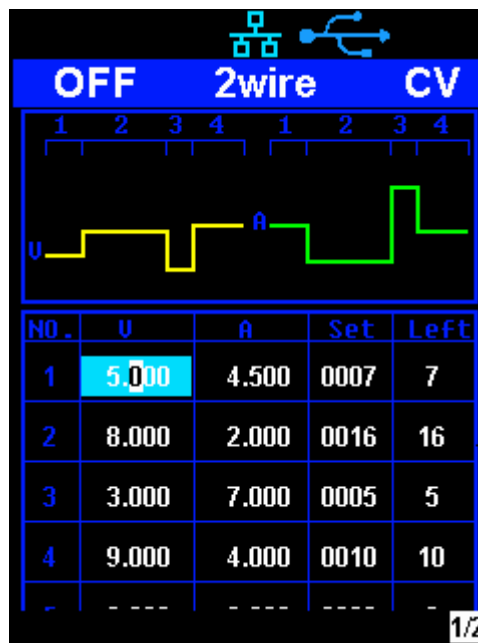
**Method 2:**

1. Press **Timer/Wave** button to enter the Timer interface.
2. Press the knob, start the timer profile.
3. Press the knob again, turn off the timer.
4. Or press the **On/Off** button for 1 second or longer to turn on/off the Timer.

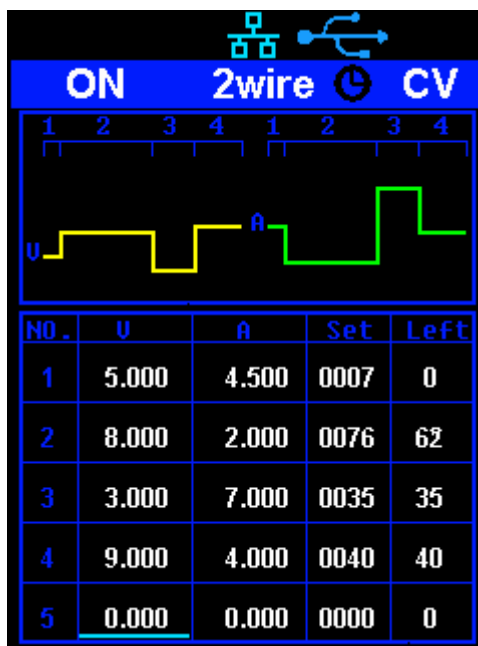

After starting the timer function, the timer will stop if you press the **On/Off** button to switch off the channel output. When the channel output is turned on again, the timer will continue counting from the last point in time it stopped. After the countdown steps have completed the timer will turn off automatically.

## 2.7 Waveform display

The SPD1000X displays the dynamic changing of the voltage and the current in the form of a trending graph.

### Operation steps:

1. Press the **Timer/Wave** key for 1 second or longer to open the channel waveform display function. Once activated, the key light will illuminate and the waveform display interface is activated.
2. Press the **On/Off** key to turn on the output. Now you can observe the near-real-time changes of the channel output parameters (current / voltage).

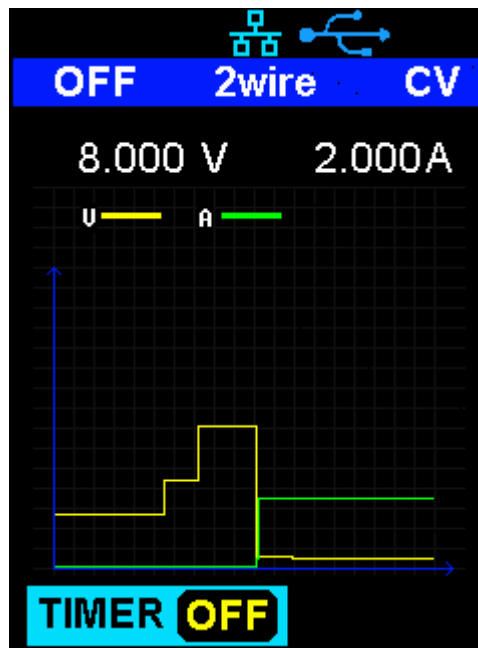

**Note:** The yellow line indicates the voltage output curve, the green line indicates the current output curve, and the ordinate axis indicates the output value.

## 2.8 Version information

Under any interface, press **Ver/Lock** to enter the version information display interface. Version information includes: the number of instrument power-up boot cycles, software version, hardware version, product model, product serial number.



## 2.9 OCP mode

The SPD1000X supports overcurrent protection. If the output current reaches the overcurrent protection value, the channel output will be closed. On the main screen, Press the **FINE** key longer to enter the OCP editing state. In this case, set the overcurrent protection value. Long press the **FINE** key again to exit the setting interface and return to the main screen.

## 2.10 Lock key

The SPD1000X allows the user to lock the front panel keys to avoid the risk of inadvertently changing a setting. Under any interface on the front panel, press the **Ver/Lock** key for 1 second or longer to enable the key lock function. At this point, the other buttons on the front panel are disabled, except for the power button. After the lock function is enabled, a “lock” icon appears at the top of the screen. Press and hold the **Ver/Lock** key again to disable the key lock function. The “Lock” icon at the top of the screen disappears.





## 2.11 Upgrade firmware

Software Upgrades are performed using Easypower, a PC-based management software program (available on the Siglent website), this is used to update the power supplies firmware via USB Device or LAN. Upgrade as follows:

### 一、Upgrade in normal Interface

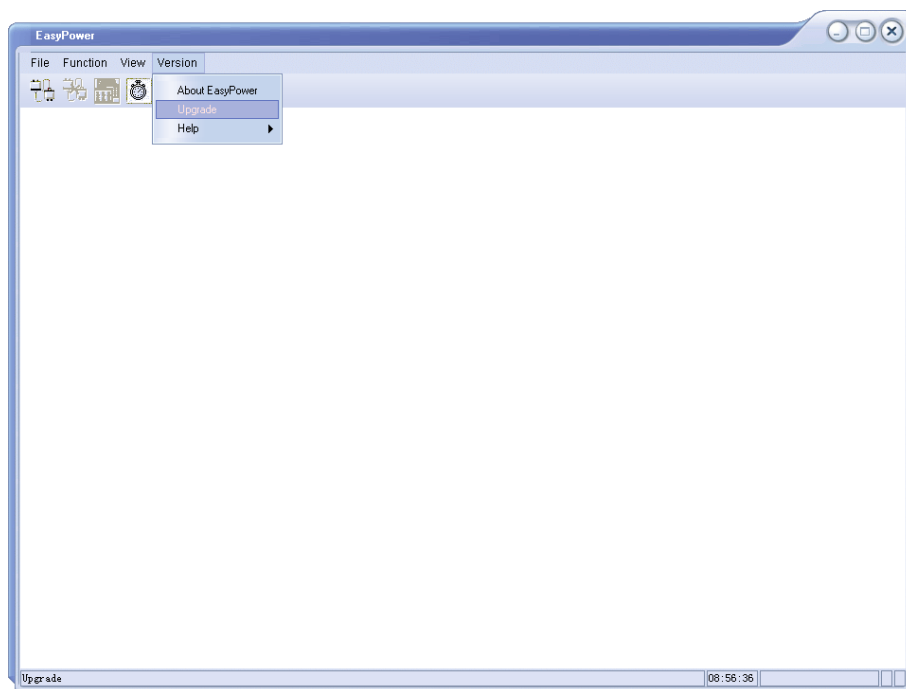
1. Open the EasyPower software after the USB interface has established its connection to the PC run the EasyPower software.
2. Click Version and then choose Upgrade in the drop-down menu to enter the USB firmware upgrade dialogue.



3. Figure shows the firmware upgrade dialogue. Click file choosing icon , and then select the file to be upgraded which must have an ADS extension.



4. As is shown in figure 4, click Upgrade button to begin the upgrade. The upgrade is finished when the progress bar completes and the instrument will automatically run the version after the upgrade.

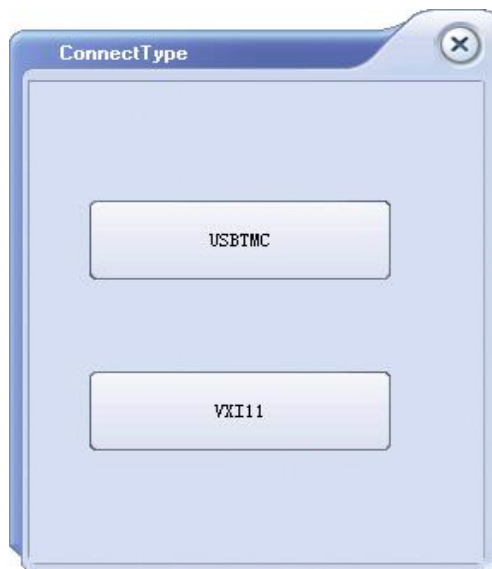

## 二、 Upgrade Via Guide Procedure

Upgrade via guide procedure also can be used if the method above does not work. Specific steps are as follows:

1. Press the knob and simultaneously turn on the instrument. It will now enter the guide procedure mode.
2. After entering the guide procedure mode, the upgrade method is the same as in the previous procedure.

## 3. Remote control

### 3.1 Control method

#### Based on NI-VISA

Users can remotely control the instrument by using NI-VISA from NI (National Instruments Corporation). In regards to NI-VISA, there is a full version and a live version (Run-Time Engine version). The full version includes NI device drivers and a tool called NI MAX. NI MAX is a user interface that controls the device. The real-time version is much smaller than the full version and includes only NI device drivers.

For example, you can download and install the full version of NI-VISA 5.4 at

<http://www.ni.com/download/ni-visa-5.4/4230/en/>.

Next use the USB cable to connect the SPD1000X (via the rear panel's USB Device connector) to the computer or use a network cable to connect the SPD1000X (through the back-panel's LAN connector) to the computer's LAN.

Based on NI-VISA, the user can remotely control the SPD1000X in two ways; one through the PC software EasyPower and the other through custom programming with SCPI commands. For more information, see Programming Examples.

#### Using Socket

Users can also use Socket through the network port and SPD1000X for TCP/IP protocol-based communications. Socket communication is a basic communication technology in computer networks. It allows applications to communicate through network hardware and the standard network protocol built into the operating system. This method requires two-way communication between the instrument and the computer network through an IP address and a fixed port number. SPD1000X Socket communication port is 5025.

Using a network cable after connecting the SPD1000X (through the rear panel LAN connector) to the local area network where the computer is located, you can customize the programming with SCPI commands to remotely control the SPD1000X. For more information, see Programming Examples.

## 3.2 Grammar conventions

The SCPI command is a tree hierarchy that includes multiple subsystems, each consisting of a root key and one or more level keys. Command keywords are separated by a colon “ : ”. The keywords are followed by optional parameter settings. Commands and parameters are separated by a space, and the parameters are separated by commas “ , ”, add a question mark “ ? ”, after the command line to inquire about this function.

Most SCPI commands are a mixture of uppercase and lowercase letters. Capital letters indicate abbreviations of shortened commands. For better program readability, use the long commands convention. For example:

[CH1:]VOLTage <voltage>

VOLT or VOLTage, uppercase and lowercase letters in any combination will work. Therefore, VoLTaGe, volt and Volt are acceptable. Other formats such as VOL and VOLTAG will generate errors.

- Brackets ( { } ) contain parameter choices. Brackets are not sent with the command string.
- Vertical line ( | ) separates parameter selections.
- Angle brackets ( < > ) indicates that you must specify a value for the parameter inside the brackets. For example, for the <voltage> parameter in angle brackets for the above command, you must specify a value for this parameter (for example, “CH1: VOLT 10”). Angle brackets do not send angle brackets along with the command string.
- Optional parameters are enclosed in square brackets ( [ ] ). If you do not specify a value for the optional parameter, the instrument uses the default value. For example, [CH1:] in the above command can be omitted (for example, “VOLT 10”). At this time, the command will operate on the current channel. Brackets are not sent with the command string.

### 3.3 Command Summary

1. \*IDN?
2. \*SAV
3. \*RCL
4. INSTRument {CH1|CH2}
5. INSTRument ?
6. MEASure:CURRent?
7. MEASure:VOLTage?
8. MEASure:POWER?
9. [SOURce:]CURRent <current>
10. [SOURce:]CURRent ?
11. [SOURce:]VOLTage <volt>
12. [SOURce:] VOLTage?
13. OUTPut
14. OUTPut:TRACk
15. OUTPut:WAVE
16. TIMEr:SET
17. TIMEr:SET?
18. TIMEr
19. SYSTem:ERRor?
20. SYSTem:VERSion?
21. SYSTem:STATus?

## 3.4 Command description

### 1. \*IDN?

<b>Command format</b>	*IDN?
<b>Description</b>	Query the manufacturer, product type, series NO. , software version and hardware version.
<b>Return Info</b>	Manufacturer, product type, series NO., software version.
<b>Example</b>	Siglent, SPD1168X, SPD1XDAD1R0001, 2.01.01.06, V1.0

### 2. \*SAV

<b>Command format</b>	*SAV <name>
<b>Description</b>	Save current state in nonvolatile memory with the specified name.
<b>Example</b>	*SAV 1

### 3. \*RCL

<b>Command format</b>	*RCL <name>
<b>Description</b>	Recall state that had been saved from nonvolatile memory.
<b>Example</b>	*RCL 1

### 4. INSTRument

<b>Command format</b>	INSTRument <CH1>
<b>Description</b>	Select the channel that will be operated.
<b>Example</b>	INSTRument CH1

---

<b>Command format</b>	INSTrument?
<b>Description</b>	Query the current operating channel
<b>Example</b>	INSTrument?
<b>Return Info</b>	CH1

## 5. MEASure

<b>Command format</b>	MEASure:CURRent? < CH1 CH2>
<b>Description</b>	Query current value for specified channel, if there is no specified channel, query the current channel.
<b>Example</b>	MEASure:CURRent? CH1
<b>Return Info</b>	3.000

<b>Command format</b>	MEASure:VOLTagE? < CH1>
<b>Description</b>	Query voltage value for specified channel, if there is no specified channel, query the current channel.
<b>Example</b>	MEASure:VOLTagE? CH1
<b>Return Info</b>	16.000

<b>Command format</b>	MEASure:POWEr? < CH>
<b>Description</b>	Query power value for specified channel, if there is no specified channel, query the current channel.
<b>Example</b>	MEASure:POWEr? CH1
<b>Return Info</b>	90.000

## 6. CURRent

**Command format** <SOURce>:CURRent <value>  
<SOURce>:={CH1}

**Description** Set current value of the selected channel

**Example** CH1:CURRent 0.5

**Command format** <SOURce>:CURRent?  
<SOURce>:={CH1}

**Description** Query the current value of the selected channel.

**Example** CH1:CURRent?

**Return Info** 0.500

## 7. VOLTage

**Command format** <SOURce>:VOLTage <value>  
<SOURce>:={CH1}

**Description** Set voltage value of the selected channel

**Example** CH1:VOLTage 15

**Command format** <SOURce>:CURRent?  
<SOURce>:={CH1}

**Description** Query the voltage value of the selected channel.

**Example** CH1:VOLTage?

**Return Info** 15.000

## 8. MODE

**Command** MODE:SET {2W|4W}



<b>Description</b>	To set the work operation of 2W or 4W
<b>Example</b>	MODE:SET 4W

## 9. OUTPut

<b>Command format</b>	OUTPut <SOURce>, <state> <SOURce>:={CH1}; <state>:={ON OFF}
<b>Description</b>	Turn on/off the channel.
<b>Example</b>	OUTPut CH1,ON

## 10. TIMER

<b>Command format</b>	TIMER:SET <SOURce>, <secnum>, <volt>, <curr>, <time> <SOURce>:={CH1}; < secnum >;=1 to 5;
<b>Description</b>	Set timing parameters of specified channel
<b>Example</b>	TIMER:SET CH1, 2, 3, 0.5, 2

<b>Command format</b>	TIMER:SET? <SOURce>, <secnum> <SOURce>:={CH1}; < secnum >;=1 to 5;
<b>Description</b>	Query the voltage/current/time parameters of specified group of specified channel.
<b>Example</b>	TIMER:SET? CH1,2
<b>Return Info</b>	3, 0.5, 2

<b>Command format</b>	TIMER <SOURce>, <state> <SOURce>:={CH1}; < state >;={ON   OFF};
<b>Description</b>	Turn on/off Timer function of specified channel

**Instruction**            The command works effectively only when <secnum> starts from 1.

**Example**                TIMEr CH1,ON

## 11. SYSTem

**Command format**    SYSTem:ERRor?

**Description**           Query the error code and the information of the equipment.

**Command format**    SYSTem:VERSion?

**Description**           Query the software version of the equipment.

**Example**                SYSTem:VERSion?

**Return Info**           2.01.01.06

**Command format**    SYSTem:STATus?

**Description**           Query the current working state of the equipment.

**Instruction**            The return info is Hexadecimal format, but the actual state is binary, so you must change the return info into a binary format. The state correspondence relationship is as follows.

**Example**                SYSTem:STATus?

**Return info**           0x0224

Explanation: The returned information is hexadecimal, so the user needs to convert to binary format when confirming the status. See the following table:

Bit NO.	Corresponding state	
0	0: CV mode;	1: CC mode
4	0: Output OFF;	1: Output ON
5	0: 2W mode;	1: 4W mode

6	0: TIMER OFF;	1: TIMER ON
8	0: digital display;	1: waveform display

## 12. IPAddr

<b>Command format</b>	IPAddr <IP address>
<b>Description</b>	Used to assign a Static Internet Protocol (IP) address to the instrument
<b>Example</b>	IPAddr 10.11.13.214
<b>Explanation</b>	This command is invalid when the power is currently set to automatically obtain the network configuration (DHCP is ON)

<b>Command format</b>	IPAddr?
<b>Description</b>	Query the software the setting of IP address
<b>Example</b>	SYSTem:VERSion?
<b>Return Info</b>	10.11.13.214

## 13. MASKAddr

<b>Command format</b>	MASKAddr <NetMask>
<b>Description</b>	Used to assign a subnet mask to the instrument
<b>Example</b>	MASKAddr 255.255.255.0
<b>Explanation</b>	This command is invalid when the power is currently set to automatically obtain the network configuration (DHCP is ON)

<b>Command format</b>	MASKAddr?
<b>Description</b>	Query the software the setting of mask address

**Example**                SYSTem:VERSion?  
**Return Info**            255.255.255.0

#### 14. GATEaddr

**Command format**      GATEaddr <GateWay>  
**Description**            Used to assign a gateway to the instrument  
**Example**                GATEaddr 10.11.13.1  
**Explanation**           This command is invalid when the power is currently set to automatically obtain the network configuration (DHCP is ON)

**Command format**      MASKaddr?  
**Description**            Query the software the setting of gateway address  
**Return Info**            10.11.13.1

#### 15. DHCP

**Command format**      DHCP {ON|OFF}  
**Description**            Turn on or off the instrument's automatic network configuration feature.  
**Example**                DHCP ON

**Command format**      DHCP?  
**Description**            This is used to query whether the current automatic network configuration of the instrument is enabled  
**Return Info**            ON

## 16. \*LOCK

**Command format** \*LOCK  
**Description** Turn on the key lock to disable local or remote settings.  
**Example** \*LOCK

**Command format** \*UNLOCK  
**Description** Turn off the key lock to validate the setting  
**Example** \*UNLOCK

## 3.5 Programming examples

This section lists examples of programming with SCPI commands based on NI-VISA or Socket in Visual C ++, Visual Basic, MATLAB, Python, and more.

### NI-VISA-based programming examples

1. First confirm that your computer has installed the NI VISA library (NI website can be downloaded from <http://www.ni.com>). The default installation path in this article is C: \Program Files\IVI Foundation\VISA.
2. This article mainly uses the power of the USB interface and PC communications, some examples involve the use of LAN interface. Please use the USB cable to connect the USB Device port on the rear panel of the power supply to the USB port on the PC. You can also use the LAN interface to communicate with the PC.
3. After the power is correctly connected to the PC for the first time, power on the instrument. At this time, the **Hardware Update** Wizard dialog box will pop up. Follow the instructions of the wizard to install the “ USB Test and Measurement Device ”.

At this point, programming preparation is completed. The following will detail the Visual C++, Visual Basic and MATLAB development environment programming examples.

### Visual C ++ programming examples

**Environment:** Win7 32bit system, Visual Studio

**Example content:** Using NI-VISA, access control devices via USBTMC and TCP/IP, send commands to read the return value.

Follow these steps to complete the example:

1. Open Visual Studio and create a new vc ++ win32 project.

Setting up the project environment to use the ni-visa library, you have two options for using ni-visa,

static mode and automatic mode:

1) static mode:

Find the files on the NI-VISA installation path: visa.h, visatype.h, visa32.lib. Copy them to your project and add them to the project. In the project .cpp file, add the following two lines

```
#include "visa.h"
```

```
#pragma comment(lib,"visa32.lib")
```

2) automatic mode

Set .h files include directory, ni-visa installation path. In our computer, we set the path to:

C:\Program Files\IVI Foundation\VISA\WINNT\include.

Set this path to the project - Properties — C / C ++ — General — Additional include path, as shown:

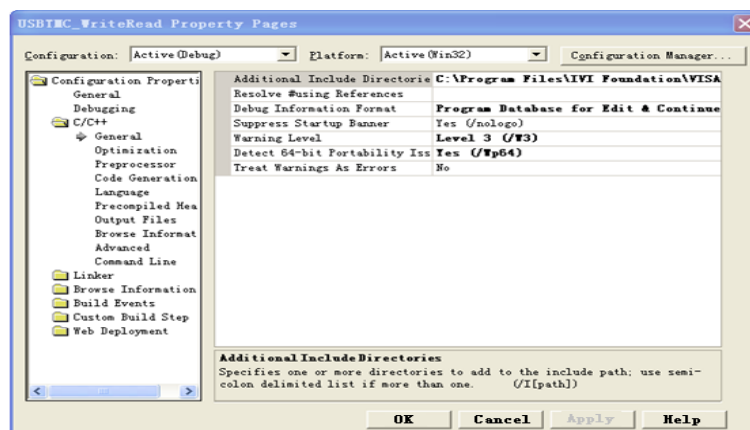

Set the library path to set the library file:

Set the library path: In your ni-visa installation path, in our computer, we set the path is:

C:\Program Files\IVI Foundation\VISA\WINNT\LIB\MSC.

Set this path to Project — Performance — Connector — General — additional library directory, as shown:

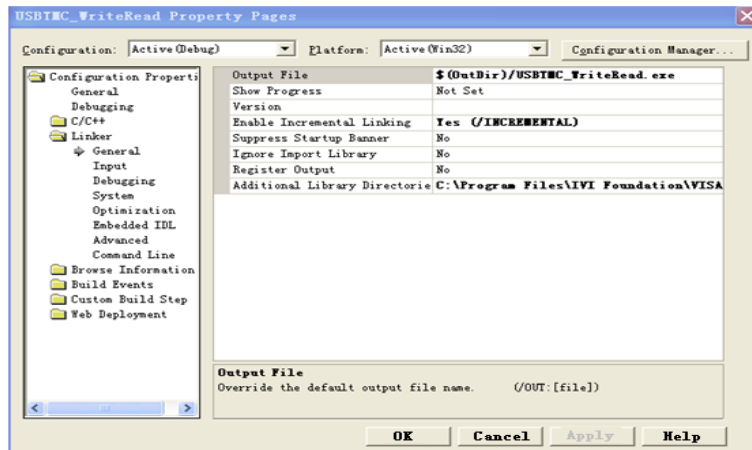

Set the library file: project — properties — Linker — Command Line — Additional Options:visa32.lib

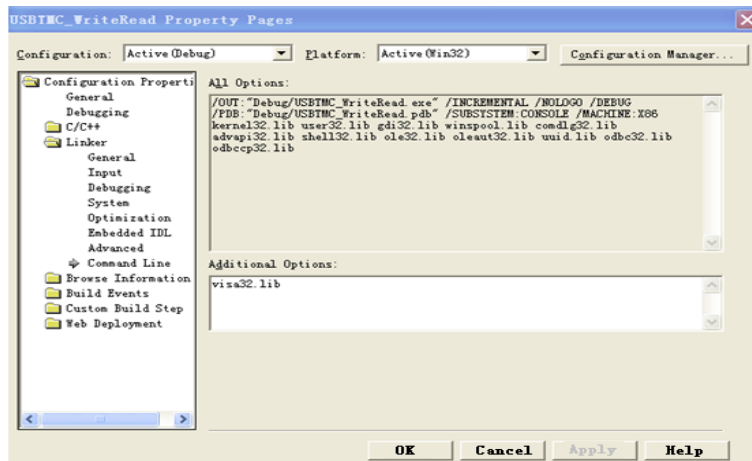

Including visa.h file: in XXX.cpp file:

```
#include <visa.h>
```

2. Add code

1) Based on USB interface code :

Write a Usbtmc\_test function.

```
int Usbtmc_test ()
```

```
{
```



```

/* This code demonstrates using NI-VISA to send synchronous read and write commands to a
USB Test & Measurement Class (USBTC) instrument */

/* This example writes "* IDN? \n" string to all USBTCs devices connected to the system and
tries to read back the result using a read-write function */

/* The general flow of the code is to open the Explorer */
/* Open the VISA session to the instrument */
/* Use viPrintf to write the instrument flag */
/* Try to read a response with viScanf */
/* Close the VISA session */

/*****/

    ViSession defaultRM;
    ViSession instr;
    ViUInt32 numInstrs;
    ViFindList findList;
    ViStatus status;
    char instrResourceString[VI_FIND_BUFLEN];
    unsigned char buffer[100];
    char stringinput[512];
    int i;

/* First, we have to call viOpenDefaultRM to get the manager's handle
*/

/* We will store this handle in defaultRM */
}

status=viOpenDefaultRM (&defaultRM);
if (status < VI_SUCCESS)
{
printf ("Could not open a session to the VISA Resource Manager!\n");
return status;
}

```

```
}  
  
    /** Look for all USB TMC VISA resources in our system          */  
  
    /* Then the number of resources stored in the system numInstrs Lane*/  
status = viFindRsrc (defaultRM, "USB?*INSTR", &findList, &numInstrs, instrResourceString);  
if (status < VI_SUCCESS)  
{  
printf ("An error occurred while finding resources.\nHit enter to continue.");  
    fflush(stdin);  
    getchar();  
    viClose (defaultRM);  
    return status;  
}
```

We will now open a VISA session for all USB TMC instruments. We have to use a handle from viOpenDefaultRM, and we have to use a string to indicate the instrument to open, which is called instrument descriptor. The format of the string can be found in the right-click parameter description in the function panel. After opening a session to the device, we get a handle to the instrument used later when using the VISA feature. The AccessMode and timeout parameters in this function are reserved for future functions. These two parameters are given the value VI\_NULL.

```
        */  
for (i=0; i<int(numInstrs); i++)  
{  
    if (i > 0)  
        viFindNext (findList, instrResourceString);  
    status = viOpen (defaultRM, instrResourceString, VI_NULL, VI_NULL, &instr);  
    if (status < VI_SUCCESS)  
    {  
        printf ("Cannot open a session to the device %d.\n", i+1);  
        continue;  
    }
```

```

    }

```

/\*\* At this point, we now have a session open to the USB TMC instrument. Now, we will use the viPrintf function to send the string `"* IDN? \ N"` to the device, asking the device to recognize

```

    */

```

```

    char * cmmmand = "*IDN?\n";
    status = viPrintf (instr, cmmmand);
    if (status < VI_SUCCESS)
    {
        printf ("Error writing to the device %d.\n", i+1);
        status = viClose (instr);
        continue;
    }

```

/\*\* Now we will try to read back the response of a device information query from the device. We will use the viScanf function to get the data. After the data is read out, the response is displayed

```

    */

```

```

    status = viScanf(instr, "%t", buffer);
    if (status < VI_SUCCESS)
        printf ("Error reading a response from the device %d.\n", i+1);
    else
        printf ("\nDevice %d:%*s\n", i+1,retCount, buffer);
    status = viClose (instr);
}

```

/\*\* We will now close the session using the viClose instrument. This action frees up all system resources

```

    */

```

```

    Return 0
}

```

2) Based on the LAN port code

Write a TCP\_IP\_Test function.

```
int TCP_IP_Test (char * pIP)
{
char outputBuffer[VI_FIND_BUFLLEN];
ViSession defaultRM, instr;
    ViStatus status;
    ViUInt32 count;
    ViUInt16 portNo;
    status = viOpenDefaultRM (&defaultRM);
    if (status < VI_SUCCESS)
    {
        printf("Could not open a session to the VISA Resource Manager!\n");
    }

char head[256] = "TCPIP0::";
char tail[] = "::INSTR";
    char resource [256];
    strcat(head,pIP);
    strcat(head,tail);
    status = viOpen (defaultRM, head, VI_LOAD_CONFIG, VI_NULL, &instr);
    if (status < VI_SUCCESS)
    {
        printf ("An error occurred opening the session\n");
        viClose(defaultRM);
    }
    status = viPrintf(instr, "*idn?\n");
    status = viScanf(instr, "%t", outputBuffer);
    if (status < VI_SUCCESS)
```

```
{  
    printf("viRead failed with error code: %x \n",status);  
    viClose(defaultRM);  
}else  
    printf ("\ndata read from device: %*s\n", 0,outputBuffer);  
status = viClose (instr);  
status = viClose (defaultRM);  
return 0;  
}
```

## Visual Basic programming examples

**Environment:** Windows 7 32-bit system , Microsoft Visual Basic 6.0

**Example Content:** Using NI-VISA, access control devices via USBTMC and TCP/IP, send commands to read the return value.

Follow the steps to complete the example:

1. Open Visual Basic, create a standard application project (Standard EXE).
2. Using the NI-VISA library to set up the project environment, click on the project's existing tab >> add module. Search for the include folder file under the NI-VISA installation path in visa32.bas and add the file.

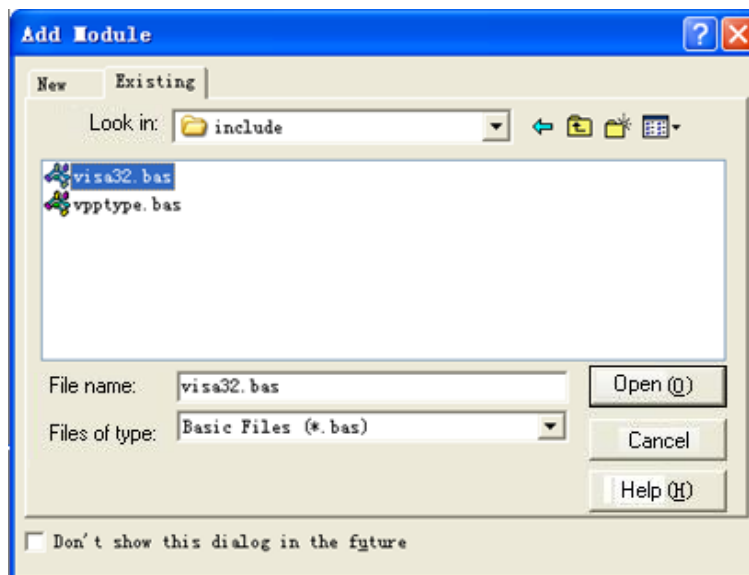

This allows VISA functions and VISA data types to be used in the program

### 3. Add code

1) Based on USB interface code:

Write Usbtmc\_test function.

```
function USBTMC_test()
```

This code demonstrates using NI-VISA to send synchronous read and write commands to a USB Test

& Measurement Class (USBTMC) instrument.

Create a VISA-USB object to connect to the USB instrument

```
vu = visa('ni', 'USB0 :: 0xF4EC :: 0x1300 :: 0123456789 :: INSTR');
```

```
fopen(vu);
```

```
fprintf(vu, '*IDN?');
```

```
outputbuffer = fscanf(vu);
```

```
disp(outputbuffer);
```

```
fclose(vu);
```

```
delete(vu);
```

```
clear vu;
```

```
end
```

2) Based on the LAN port code:

Write to the TCP\_IP\_Test function.

```
function TCP_IP_test( IPstr )
```

```
% This code demonstrates using NI-VISA to send synchronous read and write commands to a TCP /  
IP instrument.
```

```
% Create a VISA-TCPIP object to connect to an instrument with an IP address configured
```

```
vt = visa('ni', ['TCPIP0::', IPstr, '::INSTR']);
```

```
% Open the created VISA object
```

```
fopen(vt);
```

```
% Send the string "*" IDN?" To query device information
```

```
fprintf(vt, '*IDN?');
```

```
% Request data
```

```
outputbuffer = fscanf(vt);
```

```
disp(outputbuffer);
```

```
%Close the VISA object
```

```
fclose(vt);
```

```
delete(vt);
```

```
clear vt;
```

```
end
```



## Socket-based programming examples

### Python programming examples

Because the operating system itself supports Socket communication, this communication method is relatively concise. Note that the SPD1000X uses a fixed port number of 5025 for Socket communication, and the "\n" (newline) must be added to the end of the SCPI command string.

**Environment:** Windows 7 32-bit system, Python v2.7.5

**Example content:** Access control devices via Socket, send commands to read the return value.

The following is the script content:

```
#!/usr/bin/env python
#-*- coding:utf-8 -*-
#-----
# Access the control device via Socket, send a command, read and print the return #value.
#-----
import socket # for sockets
import sys # for exit
import time # for sleep
#-----
remote_ip = "10.11.13.32"
port = 5025
count = 0

def SocketConnect():
    try:
        s = socket.socket(socket.AF_INET, socket.SOCK_STREAM)
    except socket.error:
        print ('Failed to create socket.')
        sys.exit();
```

```
try:
```

```
    s.connect((remote_ip , port))
```

```
except socket.error:
```

```
    print ('failed to connect to ip ' + remote_ip)
```

```
return s
```

```
def SocketQuery(Socket, cmd):
```

```
    try :
```

```
        Socket.sendall(cmd)
```

```
        time.sleep(1)
```

```
    except socket.error:
```

```
        print ('Send failed')
```

```
        sys.exit()
```

```
    reply = Socket.recv(4096)
```

```
    return reply
```

```
def SocketClose(Socket):
```

```
    Socket.close()
```

```
    time.sleep(.300)
```

```
def main():
```

```
    global remote_ip
```

```
    global port
```

```
    global count
```

```
    s = SocketConnect()
```

```
    for i in range(10):
```

```
        qStr = SocketQuery(s, b'*IDN?\n')
```

```
    print (str(count) + ":: " + str(qStr))
    count = count + 1
SocketClose(s)
input('Press "Enter" to exit')

if __name__ == '__main__':
    proc = main()
```

## 4. Common troubleshooting

The most commonly encountered failures and their solutions are listed below. Please use these steps listed if an error occurs. If the problem persists, please contact **SIGLENT**.

### 1. The instrument will not power on.

- 1) Check whether the power is correctly connected.
- 2) Check whether the power switch at the front panel is on.
- 3) Remove the power cord and check whether the voltage selector is at the proper setting, whether the specification of the fuse is correct and whether the fuse is intact. If the fuse needs to be changed, refer to “**To Replace the Fuse**”.
- 4) If the problem remains, please contact **SIGLENT**.

### 2. The constant voltage output is abnormal.

- 1) Check whether the maximum output power of the scale currently selected fulfills the load requirement. If yes, go to the next step.
- 2) Check whether the cable connecting the load and power supply is short-circuited and is making good contact.
- 3) Check whether the load is normal.
- 4) Check whether the current setting value of this scale is proper; if it is too low, increase it accordingly
- 5) If the problem remains, please contact **SIGLENT**.

### 3. The constant current output is abnormal.

- 1) Check whether the maximum output power of the scale currently selected fulfills the load requirement. If yes, go to the next step.
- 2) Check whether the cable connecting the load and power supply is short-circuited and is making good contact.
- 3) Check whether the load is normal.
- 4) Check whether the voltage setting value of this scale is proper; if it is too low, increase it properly.
- 5) If the problem persists, please contact **SIGLENT**.

## 5. Service and Support

### 5.1 Maintenance summary

**SIGLENT** warrants that the products that it manufactures and sells will be free from defects in materials and workmanship for a period of three years from the date of shipment from an authorized **SIGLENT** distributor. If a product or CRT proves defective within the respective period, **SIGLENT** will provide repair or replacement as described in the complete warranty statement.

To arrange for service or obtain a copy of the complete warranty statement, please contact your nearest **SIGLENT** sales and service office. Except as provided in this summary or the applicable warranty Statement, **SIGLENT** makes no warranty of any kind, express or implied, including without limitation the implied warranties of merchantability and fitness for a particular purpose. In no Event shall **SIGLENT** be liable for indirect, special or Consequential damages

## 5.2 Contact SIGLENT

### Headquarters:

SIGLENT Technologies Co., Ltd

Add: Bldg No.4 & No.5, Antongda Industrial Zone, 3rd Liuxian Road, Bao'an District,  
Shenzhen, 518101, China

Tel: + 86 755 3688 7876

Fax: + 86 755 3359 1582

Email: [sales@siglent.com](mailto:sales@siglent.com)

Website: [int.siglent.com](http://int.siglent.com)

### North America:

SIGLENT Technologies America, Inc

6557 Cochran Rd Solon, Ohio 44139

Tel: 440-398-5800

Toll Free: 877-515-5551

Fax: 440-399-1211

Email: [info@siglentna.com](mailto:info@siglentna.com)

Website: [www.siglentna.com](http://www.siglentna.com)

### Europe:

SIGLENT Technologies Germany GmbH

Add: Staetzlinger Str. 70

86165 Augsburg, Germany

Tel: +49(0)-821-666 0 111 0

Fax: +49(0)-821-666 0 111 22

Email: [info-eu@siglent.com](mailto:info-eu@siglent.com)

Website: [www.siglenteu.com](http://www.siglenteu.com)



## About SIGLENT

SIGLENT is an international high-tech company, concentrating on R&D, sales, production and services of electronic test & measurement instruments.

SIGLENT first began developing digital oscilloscopes independently in 2002. After more than a decade of continuous development, SIGLENT has extended its product line to include digital oscilloscopes, isolated handheld oscilloscopes, function/arbitrary waveform generators, RF/MW signal generators, spectrum analyzers, vector network analyzers, digital multimeters, DC power supplies, electronic loads and other general purpose test instrumentation. Since its first oscilloscope was launched in 2005, SIGLENT has become the fastest growing manufacturer of digital oscilloscopes. We firmly believe that today SIGLENT is the best value in electronic test & measurement.

### Headquarters:

SIGLENT Technologies Co., Ltd  
Add: Bldg No.4 & No.5, Antongda Industrial  
Zone, 3rd Liuxian Road, Bao'an District,  
Shenzhen, 518101, China  
Tel: + 86 755 3688 7876  
Fax: + 86 755 3359 1582  
Email: [sales@siglent.com](mailto:sales@siglent.com)  
Website: [int.siglent.com](http://int.siglent.com)

### North America:

SIGLENT Technologies America, Inc  
6557 Cochran Rd Solon, Ohio 44139  
Tel: 440-398-5800  
Toll Free: 877-515-5551  
Fax: 440-399-1211  
Email: [info@siglentna.com](mailto:info@siglentna.com)  
Website: [www.siglentna.com](http://www.siglentna.com)

### Europe:

SIGLENT Technologies Germany GmbH  
Add: Staetzlinger Str. 70  
86165 Augsburg, Germany  
Tel: +49(0)-821-666 0 111 0  
Fax: +49(0)-821-666 0 111 22  
Email: [info-eu@siglent.com](mailto:info-eu@siglent.com)  
Website: [www.siglenteu.com](http://www.siglenteu.com)

Follow us on  
Facebook: [SiglentTech](https://www.facebook.com/SiglentTech)

