

# SSG6000A

# Signal Generator

## User Manual

0805A -E01A



# Guaranty and Declaration

## Copyright

SIGLENT TECHNOLOGIES CO., LTD All Rights Reserved.

## Trademark Information

SIGLENT is the registered trademark of SIGLENT TECHNOLOGIES CO., LTD

## Declaration

- ◆ SIGLENT products are protected by patent law worldwide.
- ◆ SIGLENT reserves the right to modify or change parts of or all the specifications or pricing policies at company' s sole decision.
- ◆ Information in this publication replaces all previously corresponding material.
- ◆ Any way of copying, extracting or translating the contents of this manual is not allowed without the permission of SIGLENT.
- ◆ SIGLENT will not be responsible for losses caused by either incidental or consequential in connection with the furnishing, use or performance of this manual as well as any information contained.

## Product Certification

SIGLENT guarantees this product conforms to the national and industrial standards in China as well as the ISO9001: 2008 standard and the ISO14001: 2004 standard. Other international standard conformance certification is in progress.

# General Safety Summary

Carefully read the following safety precautions to avoid any personal injury or damage to the instrument and any products connected to it. To avoid potential hazards, please use the instrument as specified.

## Use Proper AC Power Line

Only the power cord designed for the instrument and authorized by local country should

be used.

**Ground the Instrument**

The instrument is grounded through the protective earth conductor of the power line. To avoid electric shock, please make sure the instrument is grounded correctly before connecting its input or output terminals.

**Connect the Probe Correctly.**

If a probe is used, do not connect the ground lead to high voltage since it has isobaric electric potential as the ground.

**Look Over All Terminals' Ratings**

To avoid fire or electric shock, please look over all ratings and sign instruction of the instrument. Before connecting the instrument, please read the manual carefully to gain more information about the ratings.

**Use Proper Overvoltage Protection**

Make sure that no overvoltage (such as caused by a thunderstorm) can reach the product, or else the operator might be exposed to danger of electric shock.

**Electrostatic Prevention**

Operate the instrument in an electrostatic discharge protective area to avoid damages induced by static discharge. Always ground both the internal and external conductors of the cable to release static before connecting.

**Maintain Proper Ventilation**

Inadequate ventilation may cause increasing of the instrument's temperature, which will eventually damage the instrument. So keep well-ventilated and inspect the intake and fan regularly.

**Avoid Exposed Circuit or Components**

Do not touch exposed contacts or components when the power is on.

**Do Not Operate Without Covers**

Do not operate the instrument with covers or panels removed.

**Use Only the Specified Fuse.****Keep Product Surfaces Clean and Dry.**

To avoid the influence of dust and/or moisture in the air, please keep the surface of

the device clean and dry.

**Do Not Operate in Wet Conditions.**

In order to avoid short circuiting to the interior of the device or electric shock, please do not operate the instrument in a humid environment.

**Do Not Operate in an Explosive Atmosphere.**

In order to avoid damage to the device or personal injury, it is important to operate the device away from an explosive atmosphere.

The responsible body or operator should refer to the instruction manual to preserve the protection afforded by the equipment. If the equipment is used in a manner not specified by the manufacturer, the protection provided by the equipment may be impaired.

## Safety Terms and Symbols

Terms used in this manual:

**DANGER:** Indicates an injury or hazard that may immediately happen.

**WARNING:** Indicates an injury or hazard that may not immediately happen.

**CAUTION:** Indicates that a potential damage to the instrument or other property might occur.

Symbols used on the instrument. Symbols may appear on the instrument:



Hazardous  
Voltage



Protective  
Earth Ground



Warning



Chassis  
Ground

## Working Environment

### Environment

For indoor use only

### Rated voltage/frequency

100 V-240 V( $\pm 10\%$ ), 50/60 Hz

100 V-120 V( $\pm 10\%$ ), 400 Hz

### Rated input power

85W

### Temperature

Operating: 0°C to +50°C

Non-operation: -20°C to +70°C

### Humidity

Operating: 0°C to 30°C, <95%

Non-operation: 30°C to 50°C , <75%



### WARNING

To avoid short circuit inside the instrument or electric shock, please do not operate in humid environment.

---

### Altitude

Operating:  $\leq 3000\text{m}$

### Degree of protection

IP 20

### Degree of pollution

This product can work in the environment with pollution degree of 2.

### Installation (overvoltage) Category

This product is powered by mains conforming to installation (overvoltage) Category II.



### WARNING

Make sure that no overvoltage (such as that caused by thunderbolt) can reach the product, or else the operator might expose to danger of electric shock.

---

### Installation (overvoltage) Category Definitions

Installation (overvoltage) category I refers to signal level which is applicable to

equipment measurement terminals connected to the source circuit. In these terminals, precautions are done to limit the transient voltage to the corresponding low level. Installation (overvoltage) category II refers to the local power distribution level which is applicable to equipment connected to the AC line (AC power).

## Cleaning

Clean only the exterior of the instrument, using a damp, soft cloth. Do not use chemicals or abrasive elements. Under no circumstances allow moisture to penetrate the instrument. To avoid electric shock, unplug the power cord from the AC outlet before cleaning.

# Garantie et déclaration

## Droits d'auteur

SIGLENT TECHNOLOGIES CO., LTD Tous droits réservés

## Informations sur les marques

SIGLENT est la marque déposée de SIGLENT TECHNOLOGIES CO., LTD

## Déclaration

- ◆ Les produits SIGLENT sont protégés par le droit des brevets dans le monde entier
- ◆ SIGLENT se réserve le droit de modifier ou de changer des parties ou toutes les spécifications ou politiques de prix à la seule décision de l'entreprise
- ◆ Les informations contenues dans cette publication remplacent tout le matériel précédemment correspondant.
- ◆ Tout moyen de copier, d'extraire ou de traduire le contenu de ce manuel est interdit sans l'autorisation de SIGLENT.
- ◆ SIGLENT ne sera pas responsable des pertes causées par des incidents ou consécutifs en relation avec la fourniture, l'utilisation ou l'exécution de ce manuel ainsi que toute information contenue.

## Certification du produit

SIGLENT garantit que ce produit est conforme aux normes nationales et industrielles en Chine ainsi qu'à la norme ISO9001: 2008 et à la norme ISO14001: 2004. Une autre certification de conformité aux normes internationales est en cours.



---

## Résumé de la sécurité générale

Lisez attentivement les précautions de sécurité suivantes pour éviter toute blessure corporelle ou tout dommage à l'instrument et aux produits qui y sont connectés. Pour éviter les dangers potentiels, veuillez utiliser l'instrument comme spécifié.

### **Utilisez une ligne d'alimentation CA appropriée**

Seul le cordon d'alimentation conçu pour l'instrument et autorisé par le pays local doit être utilisé.

### **Mettre l'instrument à la terre**

L'instrument est mis à la terre via le conducteur de terre de protection de la ligne d'alimentation. Pour éviter les chocs électriques, veuillez vous assurer que l'instrument est correctement mis à la terre avant de connecter ses bornes d'entrée ou de sortie

### **Connectez la sonde correctement.**

Si une sonde est utilisée, ne connectez pas le fil de terre à une haute tension car il a un potentiel électrique isobare comme terre.

### **Consultez les classifications de tous les terminaux**

Pour éviter un incendie ou un choc électrique, veuillez consulter toutes les évaluations et signer les instructions de l'instrument. Avant de connecter l'instrument, veuillez lire attentivement le manuel pour obtenir plus d'informations sur les valeurs nominales.

### **Utilisez une protection appropriée contre les surtensions**

Assurez-vous qu'aucune surtension (telle que celle provoquée par un orage) ne peut atteindre le produit, sinon l'opérateur pourrait être exposé à un risque de choc électrique.

### **Prévention électrostatique**

Faites fonctionner l'instrument dans un environnement de zone de protection contre les décharges électrostatiques pour éviter les dommages induits par les décharges électrostatiques. Mettez toujours à la terre les conducteurs internes et externes du câble pour libérer l'électricité statique avant de procéder au raccordement.

### **Maintenir une ventilation adéquate**

Une ventilation inadéquate peut entraîner une augmentation de la température de l'instrument, ce qui finira par l'endommager. Gardez donc bien ventilé et inspectez régulièrement l'admission et le ventilateur.

## **SIGLENT**

---

### **Évitez les circuits ou composants exposés**

Ne touchez pas les contacts ou composants exposés lorsque l'appareil est sous tension.

### **Ne pas utiliser sans couvercles**

N'utilisez pas l'instrument avec les couvercles ou les panneaux retirés.

### **Utilisez uniquement le fusible spécifié.**

### **Gardez les surfaces du produit propres et sèches.**

Pour éviter l'influence de la poussière et / ou de l'humidité dans l'air, veuillez garder la surface de l'appareil propre et sèche.

### **Ne pas utiliser dans des conditions humides.**

Afin d'éviter un court-circuit à l'intérieur de l'appareil ou un choc électrique, veuillez ne pas utiliser l'instrument dans un environnement humide.

### **Ne pas utiliser dans une atmosphère explosive.**

Afin d'éviter des dommages à l'appareil ou des blessures, il est important de faire fonctionner l'appareil loin d'une atmosphère explosive.

L'organisme ou l'opérateur responsable doit se référer au manuel d'instructions pour préserver la protection offerte par l'équipement. Si l'équipement est utilisé d'une manière non spécifiée par le fabricant, la protection fournie par l'équipement peut être altérée.

# Termes et symboles de sécurité

Termes utilisés dans ce manuel:

**DANGER:** indique une blessure ou un danger pouvant survenir immédiatement.

**AVERTISSEMENT:** indique une blessure ou un danger qui peut ne pas se produire immédiatement.

**ATTENTION:** indique que des dommages potentiels à l'instrument ou à d'autres biens pourraient survenir.

**Symboles utilisés sur l'instrument.** Des symboles peuvent apparaître sur l'instrument:



Dangereux  
Tension



Protecteur  
Terre au sol



Avertissement



Châssis  
Sol

# Environnement de travail

## Environnement

Pour une utilisation en intérieur uniquement

### Tension / fréquence nominale

100 V-240 V ( $\pm 10\%$ ), 50/60 Hz

100 V-120 V ( $\pm 10\%$ ), 400 Hz

### Puissance d'entrée nominale

85 W

### Température

Fonctionnement: 0 °C à + 50 °C

Non-fonctionnement: -20 °C à + 70 °C

### Humidité

## SIGLENT

---

Fonctionnement: 0 °C à + 30 °C, < 95%

Non-fonctionnement: 30 °C à + 50 °C, < 75%



### ATTENTION

Pour éviter un court-circuit à l'intérieur de l'instrument ou un choc électrique, veuillez ne pas utiliser dans un environnement humide.

---

### Altitude

Fonctionnement: ≤3000m

### Degré de protection

IP 20

### Degré de pollution

Ce produit peut fonctionner dans l'environnement avec un degré de pollution de 2.

### Catégorie d'installation (surtension)

Ce produit est alimenté par le secteur conforme à la catégorie d'installation (surtension) II.

---



### ATTENTION

Assurez-vous qu'aucune surtension (telle que celle causée par le coup de foudre) ne peut atteindre le produit, sinon l'opérateur pourrait s'exposer à un risque de choc électrique.

---

### Définitions des catégories d'installation (surtension)

La catégorie d'installation (surtension) I fait référence au niveau de signal qui est applicable aux bornes de mesure des équipements connectés au circuit source.

Dans ces bornes, des précautions sont prises pour limiter la tension transitoire au niveau bas correspondant.

La catégorie d'installation (surtension) II fait référence au niveau de distribution électrique local qui est applicable à l'équipement connecté à la ligne CA (alimentation CA).

## Nettoyage

Nettoyez uniquement l'extérieur de l'instrument à l'aide d'un chiffon doux et humide.

N'utilisez pas de produits chimiques ou d'éléments abrasifs. Ne laissez en aucun cas pénétrer l'humidité dans l'instrument. Pour éviter tout choc électrique, débranchez le cordon d'alimentation de la prise secteur avant le nettoyage.

---

# SSG6000A Overview

The SIGLENT SSG6000A series is a bench top RF signal source, with an output frequency range from 100 kHz to 40 GHz. It features light weight, small size, and convenient interface make it ideal for R&D, education, production and maintenance.

## Features and Benefits

- ◆ Frequency ranges from 100 kHz up to 13.6 GHz/ 20 GHz/ 40 GHz
- ◆ 0.01 Hz frequency resolution
- ◆ Level output up to +24 dBm.
- ◆ Level accuracy  $\leq 0.7$  dB(typ.)
- ◆ Phase noise  $< -135$  dBc/Hz @1 GHz, offset 20 kHz(typ.)
- ◆ Standard AM analog modulation with internal, external and Int+Ext source
- ◆ Pulse modulation(option), on/off ratio  $\geq 70$  dBc (typ.)
- ◆ Pulse train generator(option)
- ◆ USB-power meter measurement
- ◆ Web remote control is supported, which is convenient for users to control devices remotely
- ◆ Equipped with a 5-inch (800x480) with display and a capacitive touch screen for easy and convenient operation.
- ◆ Rich communication interfaces. Standard USB-Host, USB Device (USB-TMC), LAN (VXI-11, Socket, Telnet), optional GPIB

## Contents

<b>Guaranty and Declaration</b> .....	II
<b>General Safety Summary</b> .....	II
Safety Terms and Symbols.....	V
Working Environment.....	VI
Cleaning.....	VII
<b>Garantie et déclaration</b> .....	VIII
<b>Termes et symboles de sécurité</b> .....	XI
<b>Environnement de travail</b> .....	XI
<b>Nettoyage</b> .....	XII
SSG6000A Overview.....	XIII
Chapter 1 Quick Start.....	1
1.1 Appearance size.....	2
1.2 Preparing for Use.....	3
1.2.1 Adjust the Supporting Legs.....	3
1.2.2 Connect to AC Power Supply.....	3
1.3 The Front Panel.....	4
1.3.1 Front Panel Function Keys.....	4
1.3.2 Front Panel Key Backlight.....	5
1.3.3 Digital keyboard.....	6
1.3.4 Front Panel Connectors.....	9
1.4 Rear Panel.....	10
1.5 User interface.....	13
1.6 Touch operation.....	14
1.7 Parameter setting.....	16
1.8 Help information.....	17
Chapter 2 Front Panel Operation.....	18
2.1 Frequency Setting.....	19
2.1.1 RF output Frequency.....	19
2.1.2 Freq Offset.....	20
2.1.3 RF State.....	21
2.2 Level Setting.....	21
2.2.1 Level setting.....	22
2.2.2 Level Offset.....	23
2.2.3 ALC State.....	24
2.2.4 Flatness.....	25
2.3 Sweep Setting.....	29
2.3.1 Sweep State.....	29
2.3.2 Sweep Pause.....	29
2.3.3 Step Sweep.....	30
2.3.4 List sweep.....	31
2.3.5 Direction.....	32
2.3.6 Sweep Mode.....	33
2.3.7 Trigger Mode.....	33

2.3.8	Point Trigger.....	34
2.3.9	Trigger Slope.....	35
2.4	Analog Modulation.....	37
2.4.1	Amplitude Modulation (AM).....	37
2.4.2	Pulse Modulation (PULSE).....	40
2.5	LF Setting.....	50
2.5.1	LF Source.....	50
2.5.2	LF Sweep.....	51
2.6	Utility.....	55
2.6.1	System.....	55
2.6.2	Save/Recall.....	66
2.7	Power Sensor.....	68
2.7.1	Power meter setting.....	68
2.7.2	Level Control.....	72
2.8	Shortcut Keys.....	75
2.8.1	PRESET.....	75
2.8.2	Home.....	77
2.8.3	Trigger.....	错误!未定义书签。
2.8.4	ESC.....	77
2.8.5	MOD ON/OFF.....	77
2.8.6	RF ON/OFF.....	78
Chapter 3	Application Examples.....	79
3.1	REMOTE vs LOCAL mode.....	79
3.2	Output RF signal.....	79
3.3	Correcting 10MHz Reference.....	80
3.4	Correcting Line Loss.....	81
3.5	Output a modulated signal.....	82
3.6	Output a pulse train.....	83
3.7	Download/Upload Files Using FTP (LAN).....	85
Chapter 4	Programming Overview.....	88
4.1	Remote Operation.....	88
4.1.1	Connecting via the USB Device port.....	88
4.1.2	Connecting via the LAN port.....	89
4.1.3	GPIB: Connecting via the USB-Host port.....	90
4.2	Build Communications.....	91
4.2.1	Build Communications Using VISA.....	91
4.2.2	Build Communications Using Sockets/Telnet.....	93
4.3	Remote Control Capabilities.....	94
4.3.1	User-defined Programming.....	94
4.3.2	Send SCPI Commands via NI MAX.....	94
4.3.1	Web Control.....	98
Chapter 5	Troubleshooting.....	99
5.1	General Inspection.....	99
5.2	Troubleshooting.....	99

**SIGLENT**

---

Chapter 6	Service and Support.....	104
6.1	Service Summary.....	104
6.2	Contact Us.....	105



# Chapter 1 Quick Start

Subjects in this chapter:

- ◆ Appearance size
- ◆ Preparing for Use
- ◆ The Front Panel
- ◆ Rear Panel
- ◆ User interface
- ◆ Touch operation
- ◆ Parameter setting
- ◆ Help information

## 1.1 Appearance size

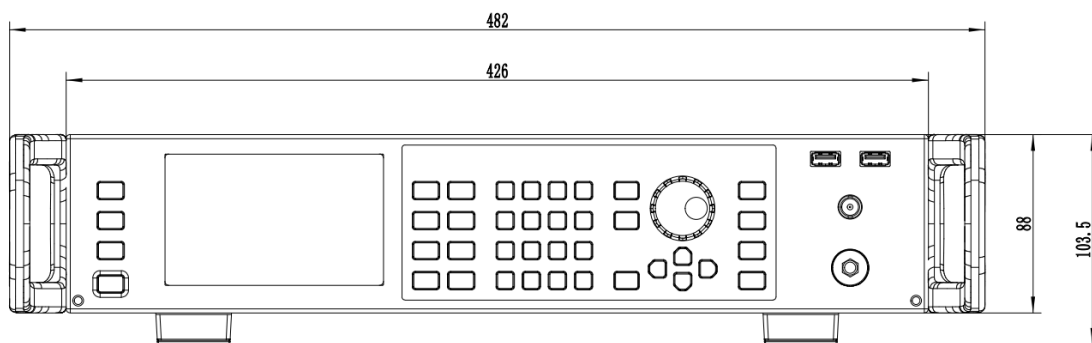

Figure 1-1 Front View

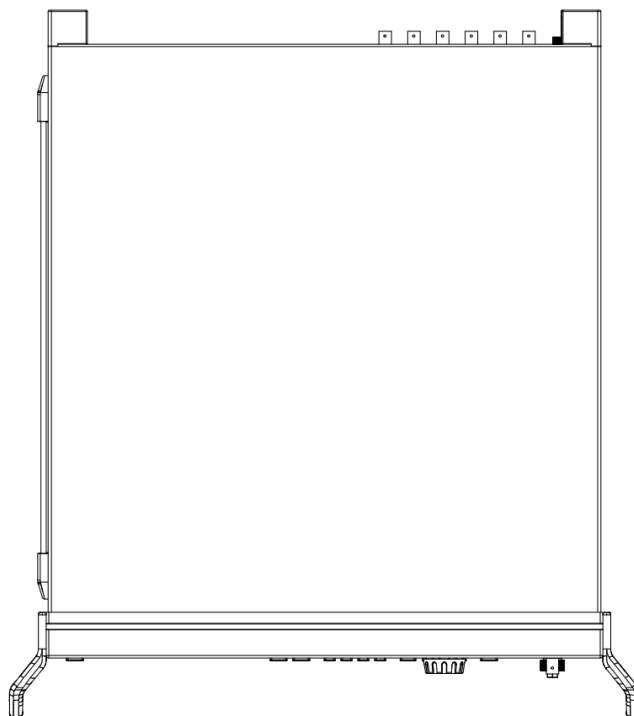

Figure 1-2 Top View

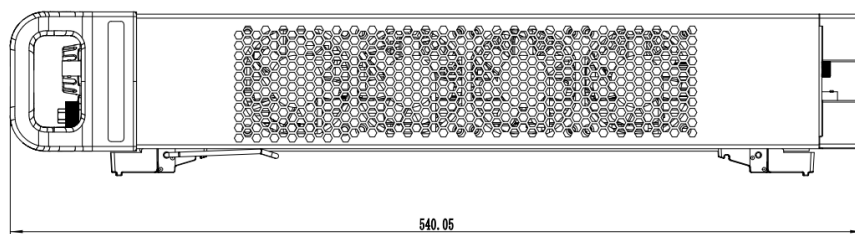

Figure 1-3 Side View

## 1.2 Preparing for Use

### 1.2.1 Adjust the Supporting Legs

For benchtop operation, you may want to use the supporting legs. Adjust the supporting feet appropriately to tilt the RF signal source upwards.

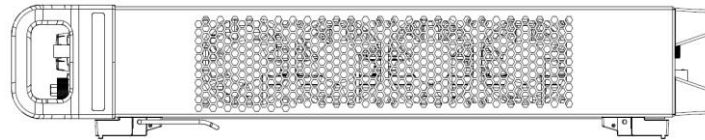

Figure 1-4 before adjusting

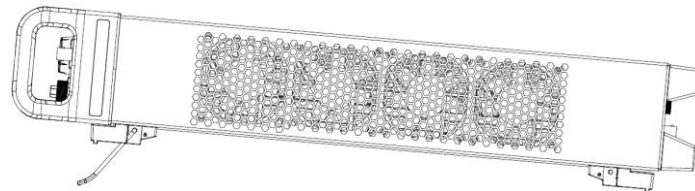

Figure 1-5 after adjusting

### 1.2.2 Connect to AC Power Supply

The RF signal source accepts 100–240V, 50/60Hz or 100–120V, 400Hz AC power supply. Please use the power cord provided to connect the instrument to the power source as shown in the figure below.

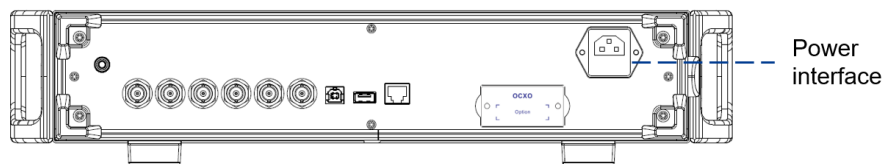

Figure 1-6 Power Interface

## 1.3 The Front Panel

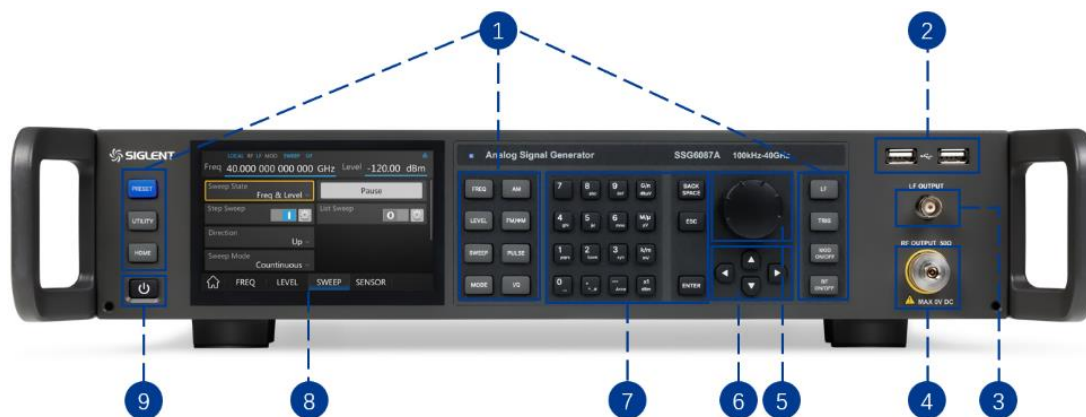

Figure 1-7 the Front Panel

Table 1-1 Front Panel Description

NO.	Description	NO.	Description
1	Function key	2	USB Host
3	LF output	4	RF output
5	Knob	6	Direction key
7	Digital keyboard	8	Touch screen display area
9	Power button		

### 1.3.1 Front Panel Function Keys

Table 1-2 Function keys description

Control Keys	Description
<b>FREQ</b>	Set frequency, frequency offset and other related parameters.
<b>LEVEL</b>	Set level, level offset, ALC state, flatness and other related parameters.
<b>SWEEP</b>	Set sweep state, step sweep, list sweep, direction and other

	related parameters.
<b>MODE</b>	Set IQ related parameters (SSG6000A not support).
<b>AM</b>	Set AM modulation parameters.
<b>FM/PM</b>	Set FM and PM modulation parameters (SSG6000A not support).
<b>PULSE</b>	Set PULSE modulation parameters.
<b>I/Q</b>	Set IQ related parameters (SSG6000A not support).
<b>ESC</b>	During the parameter editing process, pressing this key will clear the input of the active function area and exit the parameter input state.  Press this button to return to local control if previously operating the instrument remotely.
<b>LF</b>	Set LF state, LF level, LF frequency and other related parameters.
<b>TRIG</b>	When the trigger type is set to Key, press this button to perform one operation.
<b>MOD ON/OFF</b>	The main switch of various modulation modes.
<b>RF ON/OFF</b>	RF signal output switch
<b>PRESET</b>	Press this button to revert to the default parameters. The default parameters refer to the default parameter table.
<b>UTILITY</b>	System and file related operations
<b>HOME</b>	You can get back to the main interface quickly

### 1.3.2 Front Panel Key Backlight

The on/off state and the color of the backlights of some keys at the front panel indicate the working state of the SSG. The states are as listed below.

#### 1. Power Switch



Orange light constantly on indicates the instrument is in stand-by state.

Green light constantly on indicates the instrument is in power on state.

### 2. **MOD ON/OFF**

When the MOD ON/OFF is set to turn on the modulation, the light will turn on. Turn off the modulation, and the light will turn off.

### 3. **RF ON/OFF**

When the RF signal is turned on, the backlight is on. If the RF signal output is turned off, the backlight will be dark.

## 1.3.3 Digital keyboard

The front panel of the RF signal source provides a numeric keypad (as shown below). The keyboard supports English uppercase and lowercase characters, numbers and common symbols (including decimal point, blank space, negative sign and !, @, #, \$, %, ^, &, \*), mainly for editing the name of files or folders and setting parameters (refer to the "parameter setting" section).



Figure 1-8 Digital keyboard

### 1.

Digit 0 and space bar switch.

### 2.

In the English state, enter the special symbol (!, @, #, \$, %, ^, &, \*). In the digital

state, enter the decimal point.



In the digital state, enter the “-” sign, in the English state input for case switching.



When setting the amplitude, press this key to set the unit as dBuV. When setting the frequency, press this key to set the unit as GHz. If the input is a time-related parameter, press this key to set the unit as ns.



When setting the amplitude, press this key to set the unit as uV. When setting the frequency, press this key to set the unit as MHz. If the input is a time-related parameter, press this key to set the unit as us.



When setting the amplitude, press this key to set the unit as mV. When setting the frequency, press this key to set unit as kHz. If the input is a time-related parameter, press this key to set the unit as ms.



When setting the amplitude, press this key to set the unit as dBm, when setting the frequency, the unit is Hz. If the input is a time-related parameter, press this key to set the unit as s.



During the parameter editing process, pressing this key will delete the character to the left of the cursor.



In the parameter input process, pressing this key will end the parameter input and add the currently set unit for the parameter.





### 1.3.4 Front Panel Connectors

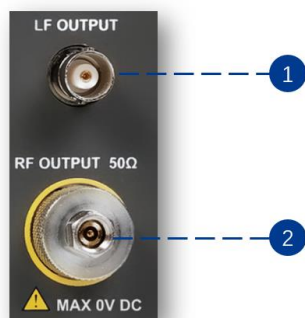

Figure 1-9 front panel connectors

#### 1. LF OUTPUT

Output the LF (low frequency) signal.

Type: female BNC.

Impedance: 50  $\Omega$ .

#### 2. RF OUTPUT

Output the RF (radio frequency) signal.

Type: Male 2.92 mm.

Impedance: 50  $\Omega$ .



---

#### CAUTION

Damage Levels: 0 Vdc, +25 dBm maximum RF power.

---

## 1.4 Rear Panel

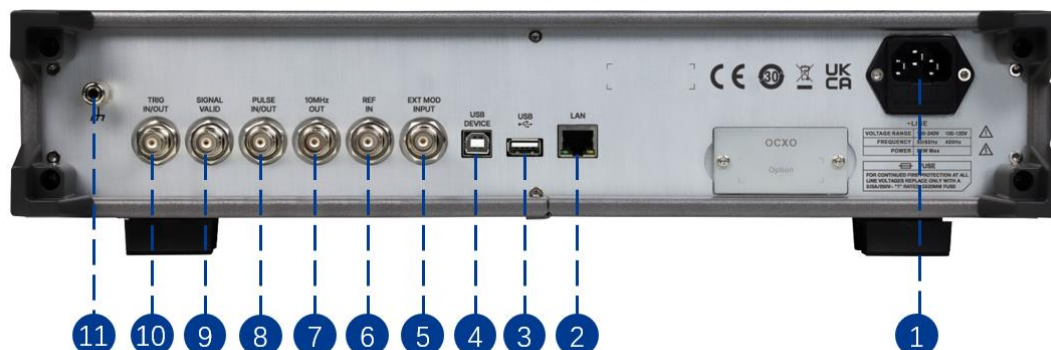

Figure 1-10 Rear Panel

### 1. AC power input terminal

The RF signal source can operate with AC power from 100 V – 240 V, 50/60 Hz, or 100 V – 120 V, 400 Hz. Please connect the RF signal source to the AC power supply with the supplied power cord.

### 2. LAN interface

Used to link the RF signal source to the computer or computer network, the SSG6000A is VXI-11 compliant, supports remote commands based on Socket and Telnet, and uses WEB for remote control. It can quickly build test systems with other standard equipment.

### 3. USB host

The RF signal source can be used as the “main device” to connect to the external USB device. The interface reads the data or state file from the U disk, or stores the current instrument state or data to the U disk.

### 4. USB Device interface

The interface can be connected to a compatible computer and controlled by software on the host computer.

#### **5. EXT MOD INPUT**

Input BNC connection for an external modulation.

#### **6. 10MHz IN**

The [10MHz IN] and [10MHz OUT] connectors are commonly used to establish synchronization between multiple instruments. The RF source can use an internal reference source or an external reference source.

If the instrument detects that there is a valid 10MHz IN signal at the [10MHz IN] connector, it will use it as an external reference source. At this point the user interface status bar shows "Ext Ref". When an external reference is lost, exceeded, or disconnected, the instrument automatically switches to the internal reference, and the screen status bar will no longer display "Ext Ref".

#### **7. 10MHz OUT**

The [10MHz IN] and [10MHz OUT] connectors are commonly used to establish synchronization between multiple instruments. The RF source can use an internal reference source or an external reference source.

If the instrument uses an internal reference source, the [10MHz OUT] connector can output a 10MHz clock signal generated by the instrument and can be used to synchronize other devices.

#### **8. PULSE IN/OUT**

The function of the connector is determined by the current mode of pulse modulation.

### 1) PULSE IN:

When the pulse source is "Ext", it is used to input external pulse signals.

### 2) PULSE OUT:

When the Pulse modulation source is "Int" and the pulse output switch is turned on, it is used to output the pulse signal generated by the internal generator. The output signal is related to "Pulse Mode", and can be set to "Single", "Double" or "Train".

## **9. SIGNAL VALID**

When the RF output frequency or amplitude is modified, the RF output connector of the front panel outputs the RF signal at the specified frequency and amplitude after a certain response and processing time in the internal circuit of the instrument. In this process, the [SIGNAL VALID] connector outputs an impulse synchronization signal to indicate the validity of the RF output signal:

- High level (3.3 V): Indicates that the RF signal is being configured;
- Low level (0 V): Indicates that the RF signal is stable (effective).

## **10. TRIG IN/OUT**

When PULSE trigger source is "Int ", the connector can be used to output the trigger signal.

When the RF Sweep, LF Sweep, or PULSE trigger mode is "Ext", the connector is used to input the external trigger signal.

## **11. Ground**

System ground terminal.

## 1.5 User interface

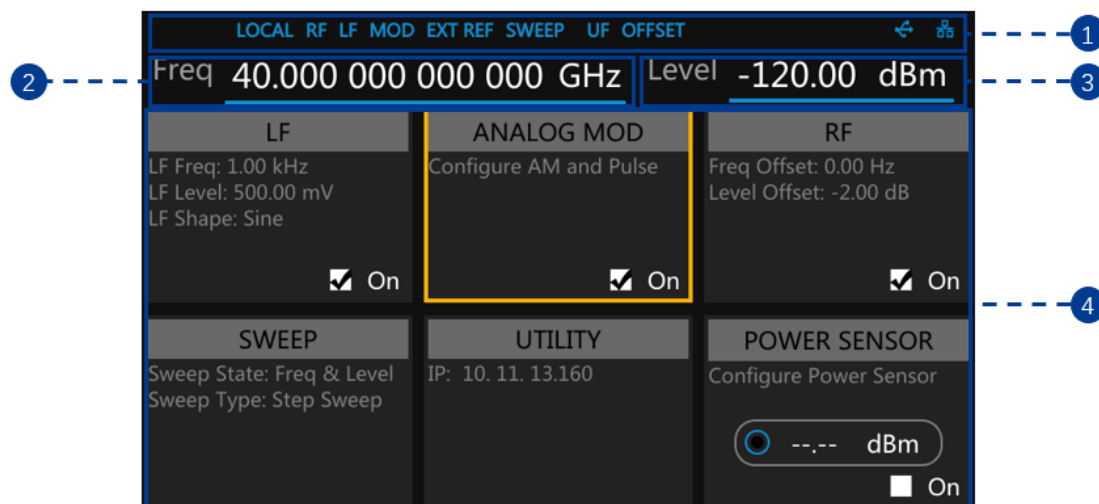





Figure 1-11 User Interface

### 1. Prompt status bar

- Display LOCAL (local) or REMOTE (remote). When REMOTE is displayed, the instrument is being controlled by a remote computer and the front panel input will be locked. To unlock the front panel (enter LOCAL mode), press **ESC** or send "SYSTEM:REMOte 0" to quit. For more details, please refer to "REMOTE vs LOCAL mode".
- EXT REF: EXT REF shows that the SSG6000A is using an external 10 MHz reference.
- LF: Low frequency signal generator state.
- MOD: The modulation function enabled.
- RF: The RF output enabled.
- SWEEP: The sweep function enabled.
- UF: Amplitude flatness function enabled.
- OFFSET: Amplitude offset enabled.
- : The identification is displayed when a USB disk is inserted.
- LAN: LAN state.  indicates that LAN is successfully connected.  indicates

that there is no network connection or network connection failed

## 2. RF frequency

RF output frequency setting. When the sweep type is "frequency" or "frequency & amplitude", the frequency scanning progress bar is displayed.

## 3. RF level

RF output level setting. When the sweep type is "amplitude" or "frequency & amplitude", the level scanning progress bar is displayed.

## 4. Touch screen display area: Display the settings under each menu

- LF: LF output state, LF waveform and LF sweep related parameters can be set.
- ANALOG MOD: Analog Modulation state. Amplitude modulation or pulse can be set.
- RF: RF output state. Frequency and level can be set.
- SWEEP: RF Sweep state and related parameters can be set.
- UTILITY: System and file related parameters can be set.
- POWER SENSOR: Power sensor state and power sensor related parameters can be set.

# 1.6 Touch operation

The RF signal source provides a 5-inch capacitive touch screen to support various gesture operations. Including:

- ◆ Click on the screen parameters or menu to edit the parameters.
- ◆ Left or right slide switches menus.
- ◆ Up and down slides the display menu.

**Note:** The scrollbar is on the right side of the menu. If there is no scrollbar, it means that only the current page exists.



## 1.7 Parameter setting

Parameter input can be performed through touch screen, keypad and digital keys, knob or direction keys. This section introduces an example of three parameter setting methods by setting the center frequency to 100 MHz.

### 1. Using the digital keyboard

- 1) Press **FREQ**;
- 2) Use the numeric key to input the value "100";
- 3) Then press  to select unit MHz;

### 2. Using the touch screen

- 1) Click the **Freq** input box on the screen to display the keypad.
- 2) Enter 100 on the keypad, then select unit MHz on the keypad.

### 3. Using the knob and the direction key

- 1) Bring the Focus Cursor on the **Freq** input box by using the knob.
- 2) Press the knob and adjust the left and right arrow keys to select the digit you wish to adjust.
- 3) Then turn the knob or press the up and down arrow keys to change the parameters until the desired value is obtained.



## 1.8 Help information

The built-in help system of RF signal source provides help information for each function and menu option on the front panel.

- ◆ Press **UTILITY** button and select **Help**. The center of the screen will pop up to help.
- ◆ Click to enter the corresponding directory.

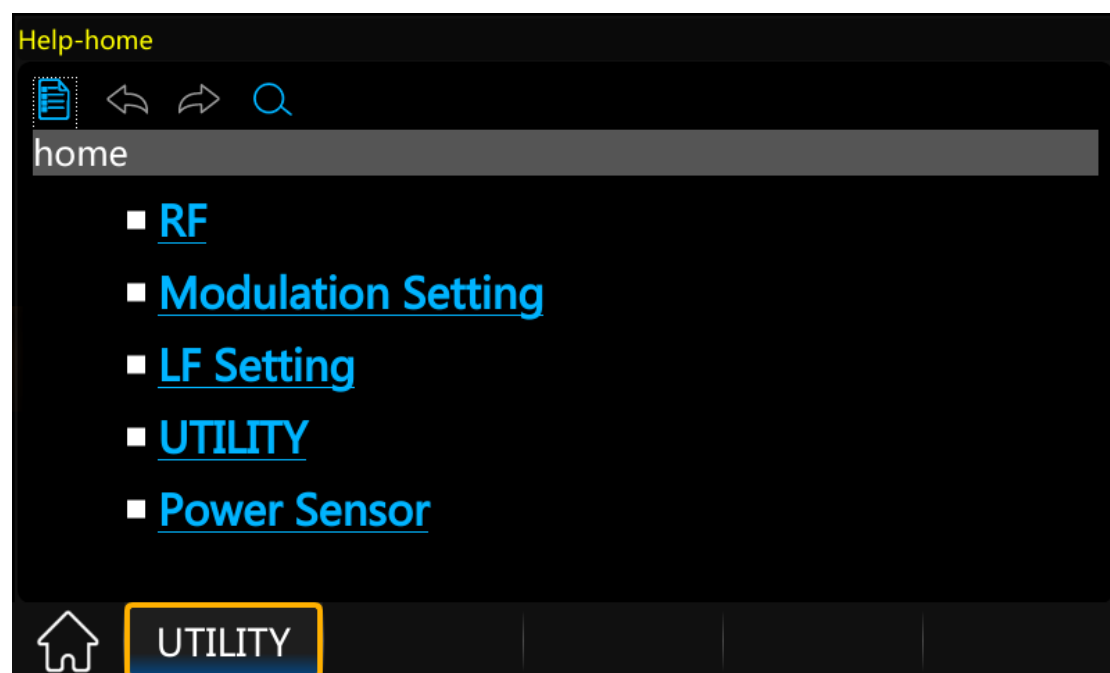

Figure 1-12 help information

## Chapter 2 Front Panel Operation

This chapter describes in detail the function keys at the front panel and the associated functions.

Subjects in this chapter:

- ◆ Frequency Setting
- ◆ RF State
- ◆ The RF State switch has the same function as the **RF ON/OFF** front panel button.
  
- ◆ Level Setting
- ◆ Sweep Setting
- ◆ Analog Modulation
- ◆ LF Setting
- ◆ Utility
- ◆ Power Sensor
- ◆ Shortcut Keys

---

## 2.1 Frequency Setting

The value of the RF frequency is displayed in the header of the display ( “Freq” ). This field provides the direct input of the RF frequency. Alternatively, you can enter the RF frequency in the “Freq” dialog.

Note that the displayed RF frequency in the header and the RF output frequency, entered in the “FREQ” dialog can be different, as explained in the following section.

If you are working with a downstream instrument, e.g., a mixer, you can enter a related parameter value in the frequency setting dialog ( “Offset” ).

The correlation between the RF frequency, the RF output frequency and the frequency offset is as follows:

$$\text{“FREQ” (in header)} = \text{“RF output frequency” (frequency in dialog)} + \text{“Freq offset” (offset in dialog)}$$

### 2.1.1 RF output Frequency

#### Setting the RF output frequency

##### 1. Keypad operation

Press **FREQ** → **Frequency** to make the focus fall on this parameter item.

- Use the numeric keypad to input the desired value and press the unit button to select the desired unit. Optional units are GHz, MHz, kHz, and Hz. Press **ENTER** to select the current unit.
- Press **ENTER** or press the knob to enter the parameter editing state, and then use the left and right direction keys to move the cursor to the desired position.

Press the up and down direction keys, rotate the knob or press the numeric keypad to modify the value. Press **ENTER**, knob or **ESC** to exit the editing mode.

## 2. Touch screen operation

Click on **RF** → **FREQ** → **Frequency** to enter the interface of RF output frequency setting.

- Click the frequency parameter to pop up the keypad interface, and then click the number symbol in the keypad to change the value. Click the unit to modify the unit. Click the tick to confirm the modified value and selected unit.

**Note:** The maximum RF output frequency is 20 GHz, and 9 kHz is the minimum.

### 2.1.2 Freq Offset

**Setting the displayed frequency offset from the RF output signal.**

This can be useful if the circuit or device shifts or alters the output frequency.

Such as when using an external mixer, by setting an offset you can read the mixer signal's frequency directly on the RF generator front panel.

#### 1. Keypad operation

Press **FREQ** → **Freq Offset** to make the focus fall on this parameter item.

- Use the numeric keypad to input the desired value and press the unit button to select the desired unit. Optional units are GHz, MHz, kHz, and Hz. Press **ENTER** to select the current unit.
- Press **ENTER** or press the knob to enter the parameter editing state, and then use the left and right direction keys to move the cursor to the desired position. Press the up and down direction keys, rotate the knob or press the numeric keypad to modify the value. Press **ENTER**, knob or **ESC** to exit the editing mode.

#### 2. Touch screen operation

Click **RF** → **FREQ** → **Freq Offset** to enter the interface of frequency offset setting.

- Click the frequency offset parameter to pop up the keypad interface, and then click the number symbol in the keypad to change the value. Click the unit to modify the unit. Click the check mark to confirm the modified value and selected unit.

**Note:**

- The relationship between the RF output frequency, the display frequency and frequency offset is:

$$\text{Display frequency} = \text{RF output Frequency} + \text{Frequency offset}$$

- The difference value between the display frequency and the frequency offset is the actual RF output frequency, which must not exceed the instrument frequency output range.

### 2.1.3 RF State

The RF State switch has the same function as the **RF ON/OFF** front panel button.

## 2.2 Level Setting

The value of the RF level is displayed in the header of the display (labeled “Level” ). This field provides the direct input of the RF level value. Alternatively, you can enter the level in the level dialog.

Note that the displayed RF level in the header and the RF output level which set in the “Level” dialog can be different, as explained in the following section.

If you are working with a downstream instrument, e. g. , an attenuator or an amplifier, you can enter the level offset value in the setting dialog (labeled “Level Offset” ).

The generator includes these parameters and displays the result in the “Level” field in the status bar, as if the downstream source and the generator were one unit. This displayed level value corresponds to the value at the RF output of the instrument and any downstream sources. However, the level provided at the RF output of the signal generator corresponds to the level value set in the “Level Setting” dialog.

When level offset is enabled, the instrument changes the color of the “OFFSET” icon from grey to blue.

Level (in header) = RF output level (level in the Level menu) + Level offset (Offset in Level menu)

### 2.2.1 Level setting

#### Setting the RF signal level

##### 1. Keypad operation:

Press the **LEVEL** → **Level** to make the focus fall on this parameter item

- Use the numeric keypad to input the desired value and press the unit button to select the desired unit. Optional units are dBm, dBuV, uV, mV, V, nW, uW and mW. Press **ENTER** to select the current unit by default.
- Press **ENTER** or press the knob to enter the parameter editing state, and then use the left and right direction keys to move the cursor to the desired position. Press the up and down direction keys, rotate the knob or press the numeric keypad to modify the value. Press **ENTER**, knob or **ESC** to exit the editing mode.

##### 2. Touch screen operation

---

Click on **RF** → **LEVEL** → **Level** to enter the interface of RF output level setting.

- Click the level parameter to pop up the keypad interface, and then click the number symbol in the keypad to change the value. Click the unit to modify the unit. Click the check mark to confirm the modified value and selected unit.

### 2.2.2 Level Offset

#### Setting the level offset from the RF signal' s level

Application: When connecting a fixed attenuation or gain, the level value after attenuation or amplification can be directly read and set on the RF source by setting a level offset.

When level offset is not zero, the status bar will display OFFSET in blue.

#### 1. Keypad operation

Press **LEVEL** → **Level Offset** to make the focus fall on this parameter item.

- Use the numeric keypad to input the desired value. Press **ENTER** or click the check mark to confirm.
- Press **ENTER** or press the knob to enter the parameter editing state, and then use the left and right direction keys to move the cursor to the desired position. Press the up and down direction keys, rotate the knob or press the numeric keypad to modify the value. Press **ENTER**, knob or **ESC** to exit the editing mode.

#### 2. Touch operation

Click on **RF** → **LEVEL** → **Level Offset** to enter the interface of level offset setting.

- Click the level offset parameter to pop up the keypad interface, and then click the number symbol in the keypad to change the value. Click the check mark to confirm the modified value.

**Note:**

- The difference value between the display level and the level offset is the actual RF output level, which must not exceed the instrument level output range.

### 2.2.3 ALC State

#### Setting the ALC's working state

ALC is Automatic Level Control. It is an adaptive control system to stabilize the RF output level.

It continuously monitors the current level and adjusts it to keep a steady state over temperature and time.

#### 1. Keypad operation

Press **LEVEL** → **ALC State** to expand the drop-down box, and then rotate the knob or press the up and down direction keys to select ALC state. Press **ENTER** to confirm.

#### 2. Touch operation

Click on **RF** → **LEVEL** → **ALC state** to select ALC state.

ALC has three functions: "Off", "On" and "Auto" :

- AUTO

Automatically turn on or off the ALC function according to the equipment state.

- On

Enable ALC permanently, regardless of the currently selected mode.

- ALC Off (S&H)

Deactivate ALC. The instrument switches to Sample & Hold (S&H) state, which still allows maintaining a constant output level. In "S&H" mode, the signal generator switches for a short time into CW mode and activates ALC. The ALC adjusts the level to the set value and the generator holds the value. Then, the generator switches



---

ALC off again and back to the previous operating mode.

## 2.2.4 Flatness

The "Flatness" function adjusts the amplitude at specific frequencies by mathematically adjusting the output by applying user-defined level correction lists. Correction is performed by the user-defined table values being added to the output level for the respective RF frequency. With frequencies which are not contained in the list, the level correction is determined by interpolation of the closest correction values.

The flatness correction function can adjust the RF output amplitude corresponding to the frequency point within the frequency range of the instrument to compensate for losses in the cable, or losses caused by other equipment.

### 1. Flatness Menu

- Keypad operation

Press **LEVEL** → **Flatness** to make the focus fall on the flatness menu, then press the knob or **ENTER** key to switch flatness status. When opened, the status bar displays the blue UF letters.

- Touch operation

Click on **RF** → **LEVEL** → **Flatness** to make the focus fall on flatness switch. Then click on the switch button to switch the flatness status.

**Note:** Flatness correct is enabled when the indicator shows the blue colored "I" and the status bar will display blue "UF". When disabled, the Flatness indicator will display a grey "0".

2. Flatness settings

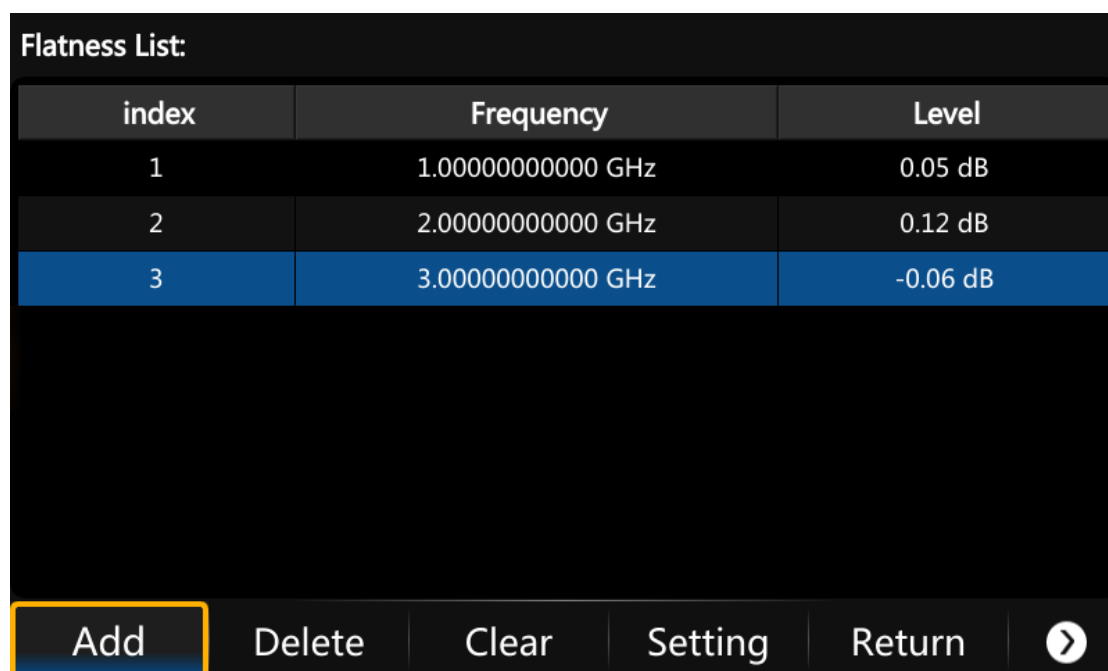

Press **LEVEL** → **Flatness**, and then click the gear icon to enter the flatness list edit page.

Table 2-1 Flatness correction list

Index	Frequency	Correction Level (dB)
1		
2		

1) Add

Click the **Add** button to add a new row after the last row.

2) Delete

Click the **Delete** button to delete the selected row.

3) Return

Click the **Return** button to return to the previous menu.



4) Setting

Click the **Setting** button to enter the set of flatness list filling.



## 5) Clear

Click the  button to empty the list.

## 6) Open

Click the ->  button to enter the file recall page, select and open existing flatness correction files. Please refer to "Save/Recall" for details.

## 7) Save

Click the ->  button to enter the file save page, save the correction data in the list. Please refer to "Save/Recall" for details.

After entered into the set of flatness list filling, you can choose one of the following three methods to fill flatness list with power sensor.

- Flatness List

In the flatness list edit page, add the frequency list. Then enter the set of flatness list filling, choose "Flatness List" method, and click "Fill Flatness with Sensor". The amplitude correction values in the flatness list will be generated.

- Manual Step

Choose "Manual Step" method, several hidden options will be enabled. Edit these options to generate frequency list, and then click "Fill Flatness with Sensor"; amplitude correction values in the flatness list will be generated.

- Sweep List

"Sweep List" method will generate frequency list according to the sweep list you have edited in the RF Sweep function. And then you can click "Fill Flatness with Sensor", amplitude correction values in the flatness list will be generated.

**Note:**

## SIGLENT

---

- You should connect a power sensor with the signal generator you use. Before you fill the flatness list with sensor, there's no need for you to turn on the RF state or sensor state. Before or after "Fill Flatness with Sensor" executed, the RF state and sensor state will be turned on or turned off automatically.
- During filling the flatness list, the pop-up message will be shown as below. You should not remove the power sensor until the process is finished.

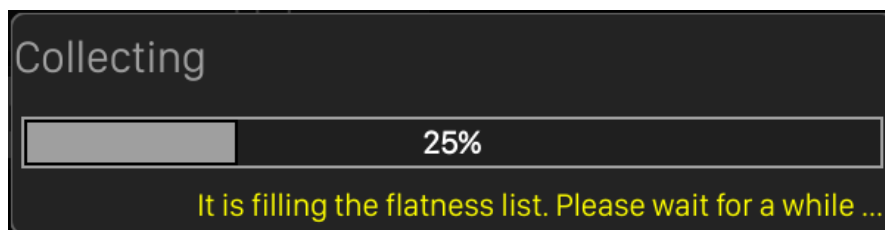

---

## 2.3 Sweep Setting

When the RF sweep function is enabled, the RF signal is output from the connector of [RF OUTPUT 50Ω] on the front panel.

**Note:** The RF signal will be on only when the RF switch is on.

Press **SWEEP** to enter RF sweep setting.

### 2.3.1 Sweep State

The sweep state is off by default. The signal generator SSG6000A offers three different RF sweep types: Freq, Level, and Freq & Level.

Clicking the drop-down box of the sweep state to choose a sweep type:

- Off: Default state. The RF sweep function is disabled.
- Freq: Enable frequency sweep. The frequency parameter bar refreshes the current frequency value in real time and the current sweep progress can be observed on the frequency sweep progress bar.
- Level: Enable level sweep. The frequency parameter bar refreshes the current level value in real time and the current sweep progress can be observed on the level sweep progress bar.
- Freq & Level: Enable frequency sweep and level sweep function. The frequency and level parameter bar refreshes the current frequency and level value in real time and the current sweep progress can be observed on the frequency and level sweep progress bar.

### 2.3.2 Sweep Pause

When the sweep state is on, the sweep pause button will be presented on the right of sweep state. Click the pause button to stop the sweep manually. After clicking the pause button, it will become “continue” and the sweep stop at this time. And

then clicking the continue button, it will become “pause” and the sweep start at this time. You can repeat the process.

### 2.3.3 Step Sweep

The step sweep state is on by default. Click the slide to switch the on-off state.

Click  to enter the parameter setting menu of step sweep.

**Note:** The step sweep and list sweep are mutually exclusive. One will shut off automatically when the other is on.

- 1) Start Freq: Initial frequency set point of the sweep.
- 2) Stop Freq: Final frequency set point of the sweep.
- 3) Start Level: Initial amplitude level set point of the sweep.
- 4) Stop Level: Final amplitude level set point of the sweep.
- 5) Dwell time: The interval time between two sweep points.
- 6) Sweep points: The number of points in a sweep. Every point is interpolated between the start parameter and stop parameter.
- 7) Sweep shape: Click the drop-down box, Sawtooth and Triangle can be selected
  - Sawtooth: Sweep period is always from the start frequency or start level to the stop frequency or stop level. The sweep sequence is similar to a “Sawtooth wave”.
  - Triangle: Sweep period is always from the start frequency or start level to the stop frequency or stop level, and then return back to the start frequency or start level. The sweep sequence is similar to a “triangle wave”.
- 8) Sweep Space: Click the drop-down box, linear and log can be selected.
- 9) Freq Step Linear/Freq Step Log: It is used to set the step value of each sweep points and is associated with “Sweep points” . It will change the “Sweep points” when setting step value or change the step value when setting “Sweep points” .

**Note:** Level sweep only support the line sweep mode.

### 2.3.4 List sweep

The list sweep state is off by default. Click the slide to switch the on-off state.

Click  to enter the table edit page of list sweep.

**Note:** The List sweep and step sweep are mutually exclusive. One will shut off automatically when the other is on.

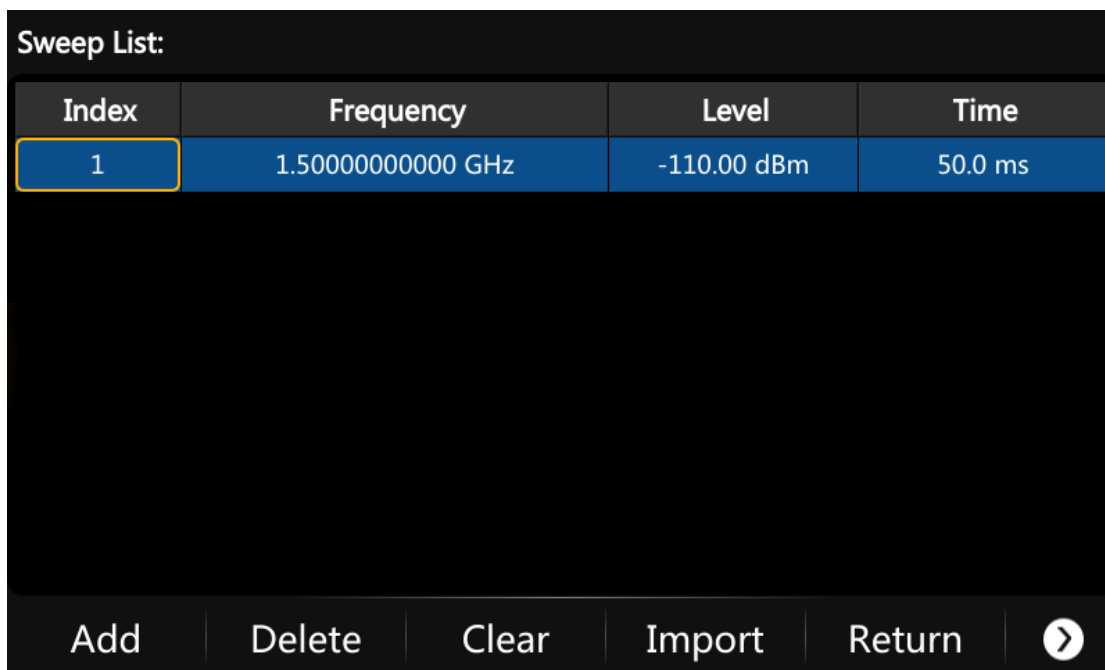

Index	Frequency	Level	Time
1	1.50000000000 GHz	-110.00 dBm	50.0 ms

Buttons: Add, Delete, Clear, Import, Return, >

As shown in the above figure, the table edit page consists of the operating buttons at the left and right of the page and the table on the middle of the page.

1) Add

Click the **Add** button to inset a new line under the current cursor.

2) Delete

Click the **Delete** button to delete the selected line.

3) Return

Click the **Return** button to return to the previous menu.

4) Clear

Click the **Clear** button to empty the list.

5) Import

Click the **Import** button to generate a new list according to the step sweep setting.

6) Open

Click the  → **open** button to enter the file recall page, select and open existing sweep list files. Please refer to "Save/Recall" for details.

7) Save

Click the  → **Save** button to enter the file save page and save the sweep list to file. Please refer to "Save/Recall" for details.

8) Parameter edit

Click each parameter in the table to set it through the touch screen keyboard or the keypad of the front panel.

The parameters of each line represent the setting of each sweep point:

- a) Frequency: Indicates the frequency of the sweep point.
- b) Level: Indicates the level of the sweep point.
- c) Time: Indicates the dwell time of the sweep point.

### 2.3.5 Direction

Sweep direction state is "Up" by default. The SSG6000A provides two types: "Up" or "Down". Click the drop-down box to enable the corresponding sweep direction.

- Up: The signal generator sweeps from the start frequency or start level to the stop frequency or stop level. The progress bar displayed in the parameter bar is swept from left to right.
- Down: The signal generator sweeps from the stop frequency or stop level to the start frequency or start level. The progress bar displayed in the parameter bar



---

is swept from right to left.

### 2.3.6 Sweep Mode

Default sweep mode is “Continuous”. The SSG6000A offers “Continuous” or “Single” sweep modes. Click the drop-down box to enable the desired mode.

- Continuous: When the trigger condition is met, the signal generator is continuously swept with the current settings.
- Single: When **Execute single sweep** is clicked, the signal generator executes a single sweep with the current settings.

### 2.3.7 Trigger Mode

The default trigger mode is “Auto”. The SSG6000A provides four types of trigger mode: “Auto”, “Key”, “Bus” and “Ext”.

Click the drop-down box of the trigger mode to select the desired type:

- Auto: The default mode. If the sweep mode is “Continuous”, just select one sweep type to start continuous sweep. If the sweep mode is “Single”, select one sweep type and click the **Execute single sweep** button to start a one-time sweep.
- Key: If the sweep mode is “Continuous”, the device will start a one-time sweep after you press the **Trigger** button on the front panel or click **Click to trigger** button on the touch screen. If the sweep mode is “Single”, first click the **Execute single sweep** button, then a one-time sweep will be started after you press the **Trigger** button on the front panel or click **Click to trigger** button on the touch screen.

- Bus: If the sweep mode is “Continuous”, the device will start a one-time sweep after receiving a “\*TRG” command over the communication bus (USB or LAN) from a controlling computer. If the sweep mode is “Single”, click the **Execute single sweep** button first, then send a “\*TRG” command to start a one-time sweep.
- External: The device receives the trigger signal input from the [TRIG IN/OUT] connector on the back panel. If the sweep mode is “Continuous”, the device will start a one-time sweep after receiving a specified polarity TTL pulse. If the sweep mode is “Single”, click the **Execute single sweep** button firstly and then the device will start one time sweep after receiving a specified polarity TTL pulse.

### 2.3.8 Point Trigger

The default point trigger mode is “Auto “. The SSG6000A provides four types of point trigger: “Auto”, “Key”, “Bus” and “Ext”.

Click the drop-down box of point trigger mode to select the desired type:

- Auto: The default mode. If the sweep mode is “Continuous”, just select one sweep type to start and sweep through each point continuously in one sweep cycle. If the sweep mode is “Single”, first click **Execute single sweep** button to sweep through each point in one sweep cycle.
- Key: If the sweep mode is “Continuous”, the device will sweep one point at a time after every press of the **Trigger** button on the front panel or click **Click to trigger** button on the touch screen. If the sweep mode is “Single”, you will need to click **Execute single sweep** button first, and then press the **Trigger** button once for every point in the sweep. The sweep will stop when finish one sweep cycle.

- Bus: If the sweep mode is “Continuous”, the device will start a point sweep after you send a “\*TRG” command. If the sweep mode is “Single”, you will need to click **Execute single sweep** button first and then send a “\*TRG” command to start sweep a point. The sweep will stop when finish one sweep cycle.
- External: The device receives the trigger signal input from the [TRIG IN/OUT] connector on the back panel. If the sweep mode is “Continuous”, the device will sweep one point when receiving a specified polarity TTL pulse. If the sweep mode is “Single”, you will need to click the single sweep button first and then the device will start sweep one point when receiving a specified polarity TTL pulse. The sweep will stop when finish one sweep cycle.

### 2.3.9 Trigger Slope

When the trigger mode or the point trigger mode is “Ext”, you can select “Positive” or “Negative” as the trigger type. The default trigger type is “Positive”. Click the drop-down box to select the desired trigger edge:

- Positive: A sweep is triggered when the rising edge of the external trigger signal arrives.
- Negative: A sweep is triggered when the falling edge of the external trigger signal arrives.

**Note:** The trigger edge control is displayed only when the trigger mode or point trigger mode is “Ext”, and is hidden in other cases.

When performing a sweep operation, the order of priority that satisfies the required conditions from high to low is: Single sweep → trigger mode → point trigger mode. For example, when the “trigger mode” and “point trigger mode” are both selected

as “key” : In the “continuous sweep”, first press the **Trigger** key to satisfy the trigger mode, and then press the **Trigger** key again to meet the point trigger sweep mode to begin sweep. In the “single sweep”, you need to press **Execute single sweep** first to meet the single sweep conditions, and then press the **Trigger** key two times to meet the sweep cycle trigger and point trigger conditions to begin sweep.

## 2.4 Analog Modulation

### 2.4.1 Amplitude Modulation (AM)

Amplitude Modulation (AM) is a technique for delivering information by linearly varying the amplitude of an RF carrier signal.

AM source can be selected as an internal source, external source or internal source + external source. To source dual tone level modulation, configure the source for internal source + external source. The internal source is shared with the LF. When the LF is turned on, the internal source can't be used as a modulation source.

Select **MOD** → **AM**, to enter the level modulation parameter setting state. The setting instructions are as follows:

Function Menu	Instructions
AM State	Turn on or off the level modulation function
AM Source	Select the modulation source, which can be Int, Ext, Int + Ext
AM Shape	Select modulation wave type
AM Rate	Frequency range: 0.01Hz~100kHz
AM Depth	Modulation depth range is from 0% to 100%
AM Sensitivity	Show the sensitivity of the external modulation source level to the modulation depth

#### 2.4.1.1 AM State

Select **MOD** → **AM** → **AM State**, and then turn on or off the level modulation.

### 2.4.1.2 AM Source

An internal and/or external source can be selected for amplitude modulation. Press **MOD**→**AM**→**AM Source** to set “Int” or “Ext” or “Int + Ext”. The default is “Int”.

#### 1. Int

When internal modulation is selected, the AM Shape, AM frequency, and AM depth are controlled by the instrument. The internal modulation setting uses the LF generator as the modulation signal source. When modulation is activated, the LF output will be disabled, if it was previously activated.

#### 2. Ext

Use an external modulation signal. The external signal is input via the **[EXT MOD INPUT]** connector on the rear panel of the instrument. The modulated signal can be an arbitrary waveform.

#### 3. Int + Ext

Use both the internal and external modulation signals. This technique can be used to source dual tone AM.

### 2.4.1.3 AM Shape

The SSG6000A supports modulation waveforms for internal “Sine” and “Square” modulation sources. Select **MOD**→**AM**→**AM Shape**, after setting **AM Source** to “Int” or “Int+Ext”, you can select AM waveform as “Sine” or “Square”.

### 2.4.1.4 AM Rate

Select **MOD**→**AM**→**AM Rate**, and set the AM rate.

1. Sine wave modulation frequency range is 0.01Hz~100kHz

- 
2. Square wave modulation frequency range is 0.01Hz~20kHz

#### 2.4.1.5 AM Depth

Set the modulation depth in percent. Select **MOD**→**AM**→**AM Depth**, and then set AM depth.

- When the “Int” modulation source is selected, the AM modulation depth is set from 0.1% to 100%. The relationship between the modulation depth  $m$  and the carrier sideband level difference  $\Delta P$  is satisfied:  $\Delta P=6.02-20*\lg(m)$

- When the “Ext” modulation source is selected, the actual modulation depth is related to the amplitude of the external input modulation signal:

**Modulation depth = amplitude of input signal × external modulation sensitivity**

For example, if the modulation depth is set to 100% (AM Sensitivity is 50%/V), the actual modulation depth will be 100% when the external modulation signal is 2Vpp (offset is 0V) and the actual modulation depth will be 50% when the external modulation signal is 1Vpp (offset is 0V).

- When selecting the “Int+Ext” modulation source, the modulation depth set is the internal source modulation depth + the external source modulation depth, and the internal source modulation depth = the external source modulation depth.

**Modulation depth = set value × 0.5 + external input signal amplitude × external modulation sensitivity**

For example, if the modulation depth is set to 100%, the modulation depth assigned to the internal source is 50%, the external source modulation depth is 50%, and the external modulation sensitivity is 25%/V. If the external modulation signal is 2Vpp (the offset is 0V), then the actual modulation depth is 100%.

### 2.4.1.6 AM Sensitivity

Display the AM depth unit offset which quantized by the amplitude of external signal. When the external signal is full scale, actual offset will be max. Specially, when the AM source is “Int+Ext”, the offsets caused by internal and external sources are evenly split. When the external signal is full scale, the offset caused by it will be half of the total offset.

**Note:** The modulation function must be activated to modulate the output signal. You can turn it on or off by pressing the **MOD ON/OFF** button or you can open it by checking the ANALOG MOD module on the home page, as shown in the figure:

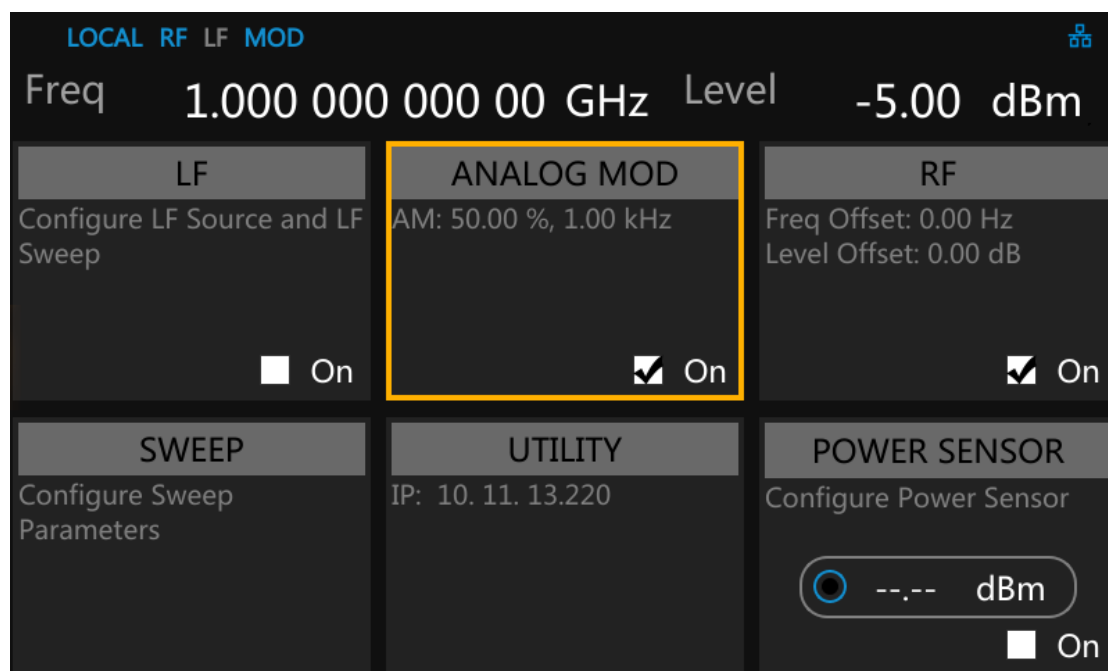

### 2.4.2 Pulse Modulation (PULSE)

Pulse Modulation represents the process of modulating an RF carrier signal with a pulse signal as a modulation signal.



### 2.4.2.1 Pulse State

Select **MOD**→**PULSE**→**Pulse State** to turn Pulse on or off.

### 2.4.2.2 Pulse Out

Select **MOD**→**PULSE**→**Pulse Out** to turn Pulse Out on or off. The default is off.

- On: Turn on the pulse output function. At this time, the signal source outputs the pulse signal generated by the internal pulse generator from the **[PULSE IN/OUT]** connector on the rear panel.

- Off: Turn off the pulse output function.

**Note:** When the modulation source is “Ext”, the pulse output function will be turned off automatically.

### 2.4.2.3 Pulse Source

Select **MOD**→**PULSE**→**Pulse Source** to set “Int” or “Ext”. The default is “Int”.

#### 1. Int

Use the internal LF generator as the modulation signal source for Pulse Modulation.

You can set Pulse Mode, Pulse Period, and Pulse Width and so on.

#### 2. Ext

Use an externally applied modulation signal. The external signal is input via the **[PULSE IN/OUT]** connector.

At this time, setting items such as pulse type, pulse period, pulse width, trigger mode, and pulse output are hidden.

### 2.4.2.4 Pulse Polarity

The default is “Normal”. Click the drop-down box to switch the pulse polarity type.

- Normal: When the pulse signal is at high level, the carrier signal is output.

And when the pulse signal is at low level, the carrier signal is blanked.

- Inverse: When the pulse signal is at low level, the carrier signal is output.

And when the pulse signal is at high level, the carrier signal is blanked.

#### 2.4.2.5 Pulse Mode

When the modulation source is “Int”, the SSG6000A provides three pulse modes: “Single”, “Double” and “Train”. The default is “Single”. Click the drop-down box to select the pulse mode.

- Single: A pulse signal is generated during one pulse period. At this time, the two settings “Double Pulse Delay” and “#2 Width” are hidden.

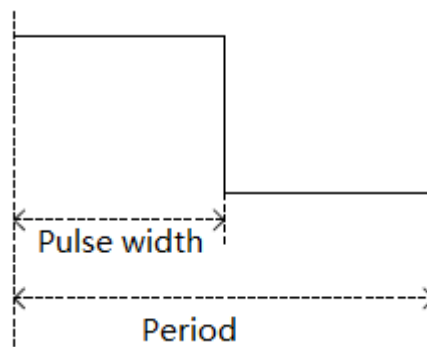

- Double: Generate two pulse signals in one pulse period. At this time, the two settings “Double Pulse Delay” and “#2 Width” are shown.

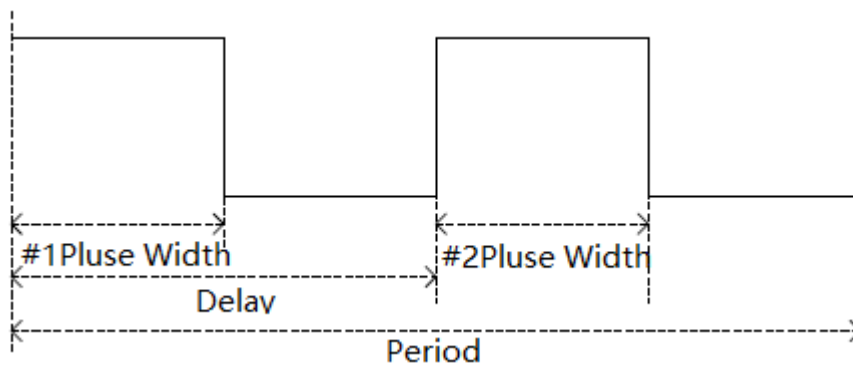

- Train: Multiple pulse signals in one pulse period. At this time, the pulse

sequence setting item appears, and the two settings “Double Pulse Delay” and “#2 Width” are hidden.

**Note:** This setting item will be hidden when the modulation source is “Ext”.

#### 2.4.2.6 Pulse Period

The pulse period represents the time interval between two adjacent periodic pulses. The period of the single pulse or double pulse modulation signal can be set by touching the screen keyboard or pressing the front panel keypad.

**Note:** This setting item will be hidden when the modulation source is “Ext” or the pulse mode is “Train”.

#### 2.4.2.7 Pulse Width

The pulse width indicates the duration when the pulse signal is at a high level. The width of the first pulse of the single pulse modulation signal or the double pulse modulation signal can be set by touching screen keyboard or pressing the front panel keypad.

**Note:** This setting item will be hidden when the modulation source is “Ext” or the pulse mode is “Train”.

#### 2.4.2.8 Double Pulse Delay

The double pulse delay indicates the delay from the start of the first pulse to the start of the second pulse in a single cycle of the double pulse modulation signal. This parameter can be set by touching screen keyboard or pressing the front panel keypad.

**Note:** This setting item will be hidden when the modulation source is “Ext” or the pulse mode is “Single” or “Train”.

#### 2.4.2.9 #2 Pulse Width

#2 Pulse Width represents the width of the second pulse of the double pulse modulation signal. This parameter can be set by touching screen keyboard or pressing the front panel keypad.

**Note:** This setting item will be hidden when the modulation source is “Ext” or the pulse mode is “Single” or “Train”.

#### 2.4.2.10 Trigger Out

The default is “off”. Click the slide switch to switch the trigger output status.

- On: Turn on the trigger output function. At this time, the signal source outputs the trigger signal generated by the internal pulse generator from the [TRIG IN/OUT] connector on the rear panel.

- Off: Turn off the trigger output function.

**Note:** When the trigger mode is “Ext Trig” or “Ext Gate”, the trigger output function will be automatically turned off. Only the trigger signal of the PULSE modulation can be output. The trigger signals of LF SWEEP and RF SWEEP cannot be output.

#### 2.4.2.11 Pulse Trigger

The trigger mode defaults to “Auto”. The SSG6000A offers five pulse trigger types: “Auto”, “Key”, “Bus”, “Ext Trig” and “Ext Gate”.

Click the drop-down box corresponding to the trigger mode to select the desired type.

- Auto: The default trigger method. The signal source satisfies the trigger condition at any time. At this time, the two settings “Trig Slope” and “Trig

---

Polarity” are hidden.

- Key: Each time the “Click to trigger” key is pressed, the signal source initiates a pulse modulation. At this time, the two settings “Trig Slope” and “Trig Polarity” are hidden.
- Bus: Send one SCPI command: “\*TRG”, the signal source initiates a pulse modulation. At this time, the two settings “Trig Slope” and “Trig Polarity” are hidden.
- Ext Trig: The source receives the trigger signal from the [TRIG IN/OUT] connector on the rear panel. Each time a TTL pulse signal of the specified polarity is received, the source initiates a pulse modulation. At this point, the “Trig Delay” and “Trigger Slope” setting will be displayed and the “Trig Polarity” setting will be hidden.
- Ext Gate: The source receives the trigger signal from the [TRIG IN/OUT] connector on the rear panel. Each time a TTL pulse signal of the specified polarity is received, the source initiates a pulse modulation within its active level. At this point, the “Trig Polarity” setting will be displayed and the “Trig Slope” setting will be hidden.

#### 2.4.2.12 Trigger Delay

The trigger delay indicates the delay from the receipt of the external trigger signal to the start of the first pulse. This parameter can be set by touching screen keyboard or pressing the front panel keypad.

**Note:** This setting item will be hidden when the modulation source is “Ext” or the pulse trigger is not “Ext Trig”.

### 2.4.2.13 Trigger Slope

The default is “Positive”, click the drop-down box to switch the trigger slope.

- Positive: Trigger a pulse when the positive slope of the external trigger signal arrives.
- Negative: Trigger a pulse when the negative slope of the external trigger signal arrives.

**Note:** This setting item will be hidden when the modulation source is “Ext” or the pulse trigger is not “Ext Trig”.

### 2.4.2.14 Trigger Polarity

The default is “Normal”; click the drop-down box to switch the trigger polarity type.

- Normal: Trigger a pulse modulation during the effective time when the external gate signal is high.
- Inverse: Trigger a pulse modulation during the effective time when the external gate signal is low.

**Note:** This setting item will be hidden when the modulation source is “Ext” or the pulse trigger is not “Ext Gate”.

### 2.4.2.15 Pulse Train

When the Pulse Mode is set to Train, the Pulse Train option appears.

Click Pulse Train to enter the table edit page for the pulse sequence.

Pulse Train:			
Index	On Time	Off Time	Count
1	1.00000 ms	1.00000 ms	1

Add   Delete   Clear   Diagram   Return   

As shown above, the pulse sequence edit page consists of the setting buttons and the middle table area:

1) Add

Click the **Add** button to automatically insert a new line on the next line where the current cursor is located.

2) Delete

Click the **Delete** button to delete the line where the current cursor is located.

3) Clear

Click the **Clear** button to clear and reset the current list.

4) Diagram

Click the **Diagram** button to enter the pulse sequence diagram page and view the pulse sequence graph.

5) Return

Click the **Return** button to return to the previous menu.

6) Open

Click the -> **open** button to enter the file system directory. At this time, you can select and read the sequence file previously saved in the device, and you can edit and modify the sequence next step.

7) Save

Click the -> **Save** button to save the pulse sequence to file.

**Note:** For details on loading/saving files, please refer to the related introduction in “Save/Recall” .

The parameters in each row represent the settings for each pulse signal in a single pulse period:

- 1) Index: indicates the serial number of the pulse signal corresponding to this line.
- 2) On Time: Indicates the duration of the pulse signal being high.
- 3) Off Time: Indicates the duration of the pulse signal being low.
- 4) Count: Indicates the number of repetitions of this pulse signal.

The pulse sequence schematic page is shown below:

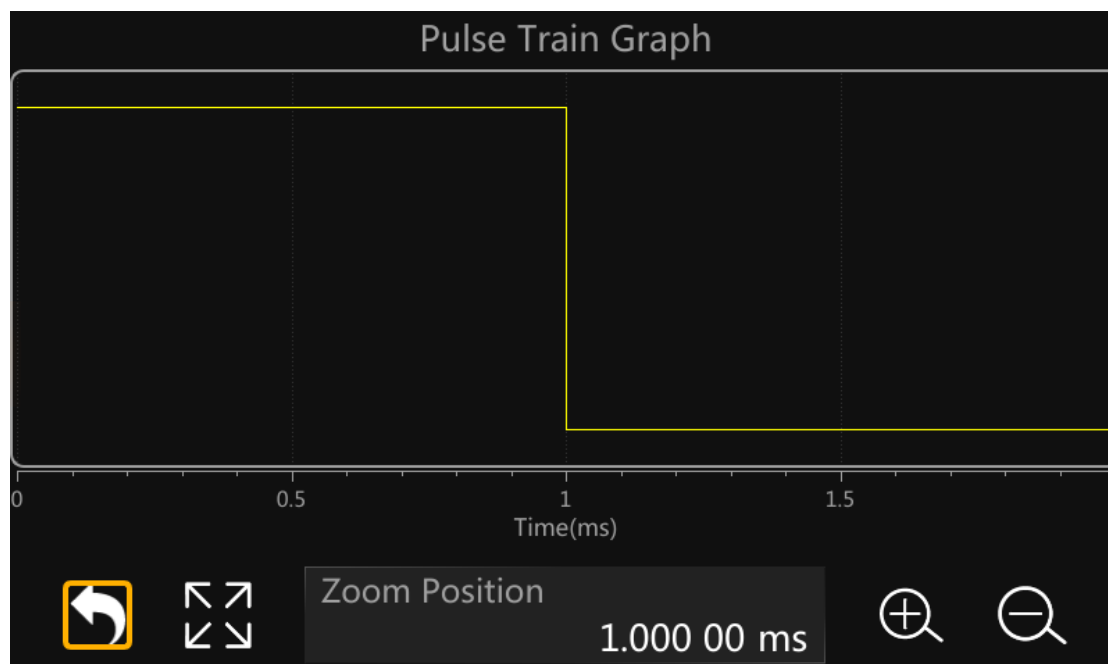







As shown, the page consists of the upper drawing area and the lower control area:



1) Plot area: A schematic diagram of the waveform generated from the data entered in the current pulse sequence table. The vertical direction represents the high and low level changes of each pulse signal in the pulse sequence, and the position of the high and low levels in the direction is unchanged. The horizontal direction represents the high and low level duration of each pulse signal in the pulse sequence.

You can use the zoom feature to observe different details of the waveform.

2) Control area

- Click the  button to return to the previous pulse sequence table edit page;
- Click the  button to restore the sequence graph to the initial state;
- Click the  button to zoom in the center position of the current waveform;
- Click the  button to zoom out the center position of the current waveform;
- The “Zoom Position” parameter sets the center position of the current graph, and the operations of the “Zoom In” and “Zoom Out” buttons are based on this position. It can be set by touching screen keyboard or pressing the front panel keypad to shift the current waveform to the corresponding position.

The scaling operation for the drawing area can be achieved in the following ways:

- Zoom in, zoom out and restore through the Control Area's ,  and  buttons. Change the value of Zoom Position to set the center of the graph.
- You can use your fingers to zoom in or zoom out or move the center of the graph directly on the touch screen.

## 2.5 LF Setting

### 2.5.1 LF Source

The SSG6000A has an internal low-frequency signal generator that can be used as an internal source for low-frequency signal output or analog modulation. When output as a low-frequency signal, the LF output supports several common waveforms, and the frequency and amplitude of the low-frequency signal can be set. Press **LF** to enter the LF parameter settings. Setting description is as follows:

#### 2.5.1.1 LF State

Select **LF** → **LF Source** → **LF State** to turn LF on or off.

#### 2.5.1.2 LF Frequency

Select **LF** → **LF Source** → **LF Frequency** to set the frequency of the LF output signal. The setting range is 0.01Hz ~ 1MHz.

#### 2.5.1.3 LF Level

Select **LF** → **LF Source** → **LF Level** to set the LF output amplitude, the range is from 1mV ~ 3V, and supports a number of unit types.

#### 2.5.1.4 LF Level Offset

Select **LF** → **LF Source** → **LF Level Offset** to set the amplitude offset of the LF output.

The setting range is  $|LF\ Level\ Offset| \leq \min(2.5V - \frac{1}{2}LF\ Level, 2V)$

### 2.5.1.5 LF Shape

Select **LF** → **LF Source** → **LF Shape**, you can select the LF output signal waveform. Current waveform types are “Sine”, “Square”, “Sawtooth”, “Triangle” and “DC”. The default LF output signal is the “Sine” waveform.

### 2.5.1.6 LF Phase

Select **LF** → **LF Source** → **LF Phase** you can set the LF phase. The setting range is  $-360^{\circ} \sim 360^{\circ}$ , and supports degrees or radian units.

## 2.5.2 LF Sweep

### 2.5.2.1 Sweep State

Select **LF** → **LF Sweep** → **Sweep State** to activate the LF sweep signal generation.

### 2.5.2.2 Start Freq

Select **LF** → **LF Sweep** → **Start Freq** to set the start frequency.

### 2.5.2.3 Stop Freq

Select **LF** → **LF Sweep** → **Stop Freq** to set the stop frequency.

#### 2.5.2.4 Center Freq

Select **LF** → **LF Sweep** → **Center Freq** to set the center frequency.

#### 2.5.2.5 Freq Span

Select **LF** → **LF Sweep** → **Freq Span** to set the frequency Span.

#### 2.5.2.6 Direction

Select **LF** → **LF Sweep** → **Direction** to set the sweep direction.

#### 2.5.2.7 Sweep Time

Select **LF** → **LF Sweep** → **Sweep Time** to define the duration of a full LF sweep.

#### 2.5.2.8 Trigger Mode

Select **LF** → **LF Sweep** → **Trig Mode** to set the LF sweep mode. If you change the sweep mode during the execution, the signal generator stops the sweep and starts with the next trigger event at the initial value.

##### 1. Auto

Generate a continuously repeating sweep signal immediately after activating the sweep mode.

##### 2. Key

Generate a single sweep cycle each time the **Trigger** button on the front panel is pressed or the “Click to Trigger” button on the touch screen is clicked. If one sweep cycle is completed, the instrument waits for the next trigger event.

### 3. Bus

Generate a single sweep cycle each time the instrument receives a “\*TRG” SCPI command over the communication bus (USB or LAN) from a controlling computer.

### 4. Ext

Generate a single sweep cycle when an external trigger event received from the [TRIG IN/OUT] connector on the back panel occurs.

## 2.5.2.9 Sweep Shape

Select **LF** → **LF Sweep** → **Sweep Shape** to select the waveform shape of the sweep signal.

### 1. Sawtooth

The sweep runs from the start to the stop frequency. Each subsequent sweep starts at the start frequency, which means that the shape of the sweep sequence resembles a Sawtooth.

### 2. Triangle

The sweep runs from start to stop frequency and back, which means the shape of the sweep resembles a triangle. Subsequent sweep starts at the initial start frequency.

## 2.5.2.10 Sweep Space

Select **LF** → **LF Sweep** → **Sweep Space** to select the mode for the calculation of the frequency sweep intervals.

### 1. Linear

In this mode, the frequency of the sweep signal varies in linear steps. Unit: Hz.

### 2. Logarithmic

In this mode, the frequency of the sweep signal varies in logarithmic steps. Unit: %.



---

## 2.6 Utility

### 2.6.1 System

#### 2.6.1.1 Setting

##### 1. Language

Set the display language of SSG6000A. SSG6000A supports Chinese/English menus, help and interface display.

Press **UTILITY**→**Setting**→**Language** to expand drop down list, and then select the desired language.

##### 2. Screen Saver

Set the state of screen saver. When screen saver is switched on, the on-screen display will turn off when there is no touch or key operation within the specified time. Click the touch screen or press any key to resume.

Press **UTILITY**→**Setting**→**Screen Saver** to expand drop down list, and then select “off”, “10 s”, “1 min”, “5 min”, “15 min”, “30 min”, “1 hour” or “2 hour”.

##### 3. Power On

Set the type of parameter configuration to be loaded when the instrument startup.

Press **UTILITY**→**Setting**→**Power On** to expand drop down list, and then select “Default” or “Last”.

Default: The default factory settings will be loaded when the instrument is powered on. For more details, please refer to Table 2-3.

Last: The system settings before the last power-off will be loaded automatically

when the instrument is powered on.

#### 4. Preset Type

Set the parameters for the Preset configuration of the instrument.

Press **UTILITY**→**Setting**→**Preset Type** to expand drop down list, and then select “Default” or “User”.

- Default: The default factory settings will be loaded when **PRESET** is pressed. For more details, please refer to Table 2-3.

- User: The user specified configuration will be loaded when **PRESET** is pressed.

After “User” is selected, click  button to load the configuration file.

For detailed operation procedure please refer to “Save/Recall”.

#### 5. Factory Reset

Restore the instrument configuration to factory settings.

Press **UTILITY**→**Settings**→**Factory Reset**, set the instrument parameters and status to factory defaults.

In addition to loading the default settings, the factory reset will also configure the following functions and parameters as default values.

Table 2-2 Factory default

Parameter	Default
<b>Setting</b>	
Language	Chinese/English (depend on factory config)
Preset Type	Default
Beeper	On
Screen Saver	Off



Power On	Default
Power On Line	Off
10M Adjustment	Off
<b>Interface</b>	
DHCP State	Off
IP Address	10. 11. 13. 220
Subnet Mask	255. 255. 255. 0
Gateway	10. 11. 13. 1
VNC Operable	On
GPIB Address	18
<b>Level</b>	
Flatness	null
<b>Sweep</b>	
List sweep	Keep only one default scan point
<b>Mode</b>	
Pulse Train	Keep only one default pulse

#### 6. Reset & Clear

Set “Reset & Clear” will restore the instrument configuration to factory settings, as well as clean up files stored by users in “Local” folder.

Press **UTILITY** → **Settings** → **Reset & Clear** to set the instrument parameters and status to factory defaults and clean up local files.

#### 7. Beeper

Set whether the beeper make a sound when clicking any button, input box or check box.

Press **UTILITY** → **Setting** → **Beeper** to switch the beeper state.

## 8. Power On Line

Set whether the instrument needs to press the power on button to start after the line power is turned on. In some situations, you may want the instrument to automatically restart if the line power is restored.

- Off: You need to manually press the power key on the front panel to start the instrument when the line power is available.
- On: If line power is available, the instrument starts automatically.

Press **UTILITY** → **Setting** → **Power on Line** to switch the state.

## 9. 10M Adjustment

Modifying the Reference Oscillator Code will change the reference frequency. You can externally connect a frequency counter from the 10MHz OUT connector on the rear panel and adjust the 10MHz reference by modifying the code.

- Press **Save Ref Osc Setting** to save “\*.dac” file to store the Ref Oscillator Code you currently set.
- Press **Recall Ref Osc Setting** to recall the Ref Oscillator Code you have stored.
- Press **Reset to default** to set the Ref Oscillator Code to default value, and the reference frequency will reset to the original value, too.

Press **UTILITY** → **Setting** → **10M Adjustment** to switch the state.

## 10. Time Setting

Set the display time of the instrument.

Press **UTILITY** → **Setting** → **Time Setting**, then move the cursor to specified location and change the time by inputting the value.

---

### 2.6.1.2 System Info

Press **UTILITY** → **System Info** to view the instrument's system information, including:

- Model
- Host ID
- Serial Number
- Software Version
- Uboot-OS Version
- Hardware Version
- Startup Times

### 2.6.1.3 Interface

Press **Utility** → **Interface** to view the instrument's remote control interface information, including:

#### 1. LAN Settings

##### 1) DHCP State

Set the state of DHCP.

Press **UTILITY** → **Interface** → **DHCP State**, then press **ENTER** or knob to change the state.

When the DHCP state is on, the network DHCP server will configure the IP address, subnet mask and gateway automatically according to the current network condition.

When the DHCP state is off, the IP address, subnet mask and gateway will be configured by the user.

##### 2) IP Address

Configure the network IP address.

Press **UTILITY** → **Interface** → **IP Address** to input IP value.

##### 3) Subnet Mask

## SIGLENT

---

Configure the network subnet mask.

Press **UTILITY** -> **Interface** -> **Subnet Mask** to input subnet mask value.

### 4) Gateway

Configure the network gateway.

Press **UTILITY** -> **Interface** -> **Gateway** to input gateway value.

## 2. Web Setting

Web Setting includes the settings of VNC Operable state, Web password, Hostname and FTP Password. Press **UTILITY** -> **Interface** and scroll the scroll bar on the right side of the window to see the entire Web Setting content.

Notice: put your mouse or finger in the middle of the screen and drag UP and DOWN.

You will see the Web Setting menu appear.

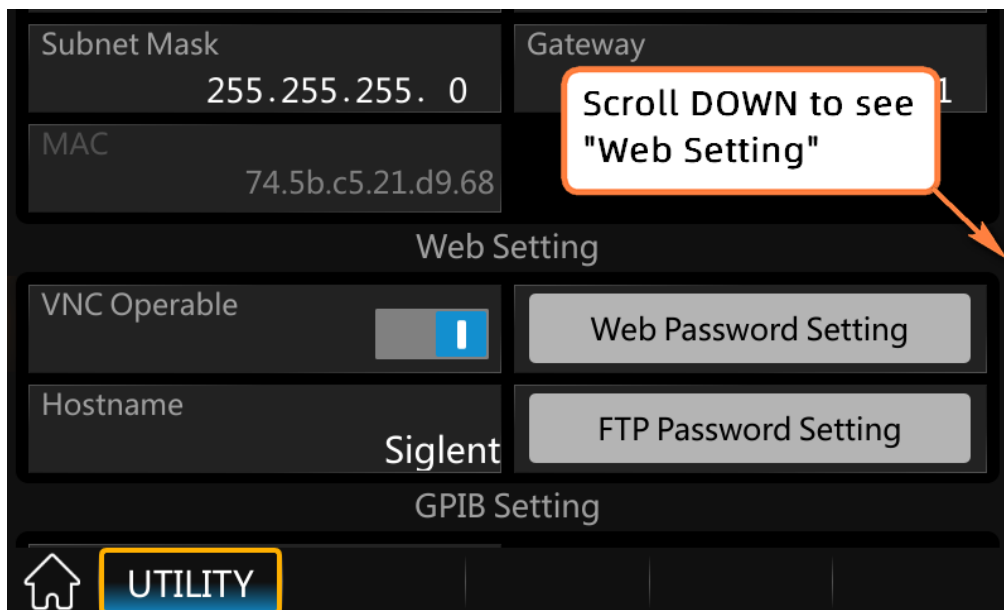

### 1) VNC Control Setting

Turn the Web control function on or off by turning the **VNC Operable** button on or off.

When the VNC operation is enabled, users can control the instrument through a Web

browser. Enter the IP address of the signal generator in a Web browser, and you can log in to the VNC.

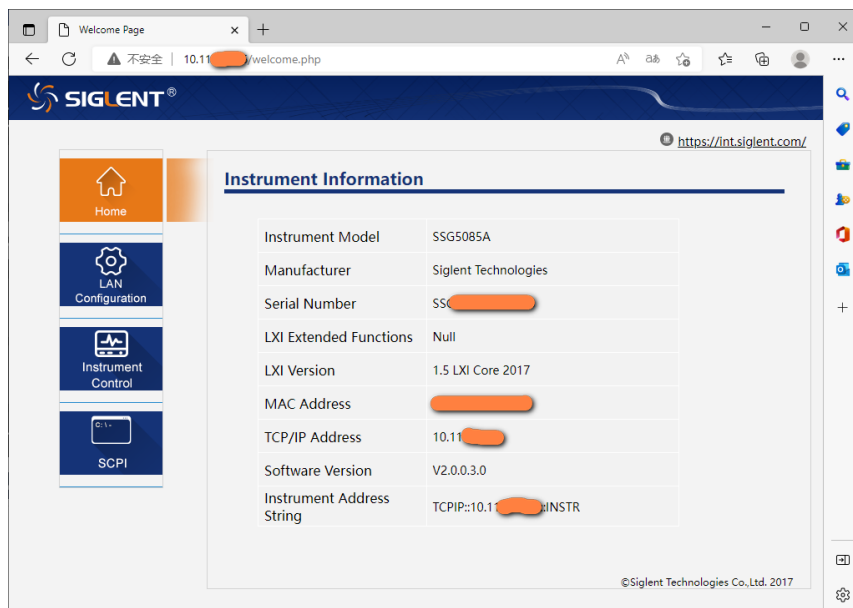

If you want to control the instrument or send SCPI in the VNC, a dialog box will pop up where you need to enter your login password. You can set the log in password in **Web Password Setting**.

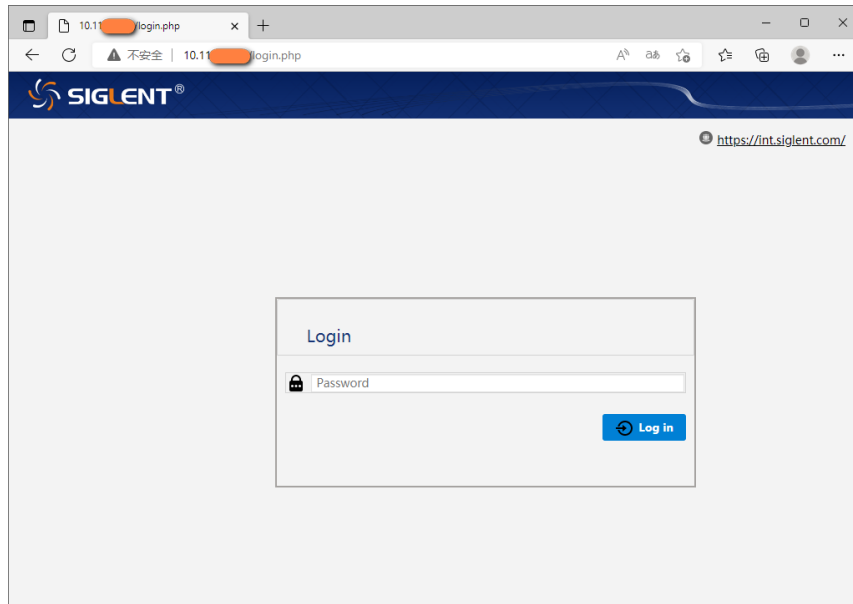

Press **UTILITY** → **Interface** → **Web Password Setting** to enter the Web Password Setting interface. You can change the password by entering the Current password, New Password and Confirm password. You can also set the password to the default value "siglent" by clicking the "Reset to default" button.

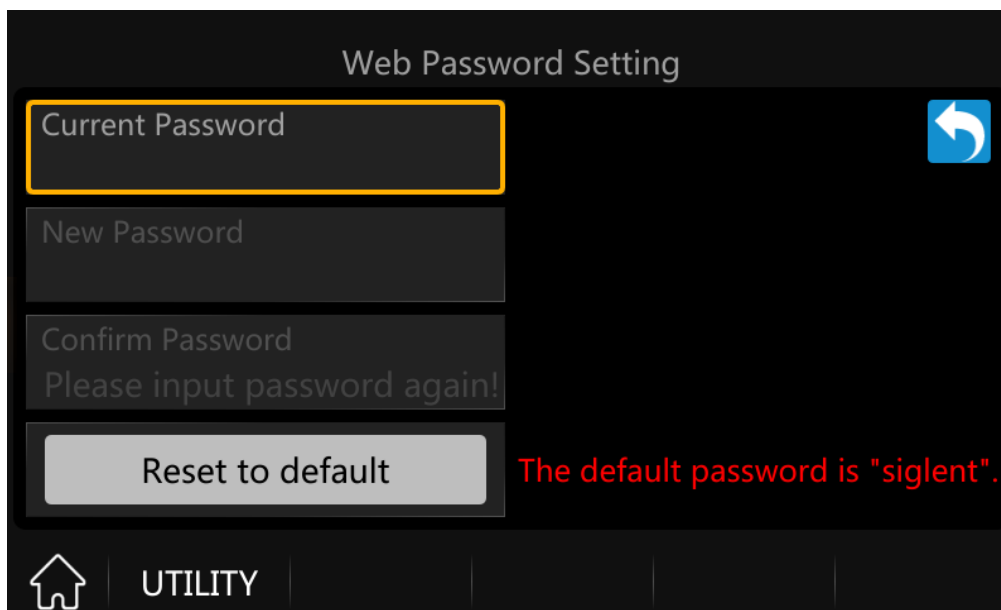

## 2) Hostname Setting

Press **UTILITY** → **Interface** → **Hostname** to set the hostname. The default value is “Siglent” .

If the host resides on the same network segment as the signal generator, you can enter <http://Hostname.local> in the web browser to log in to the VNC.

## 3) FTP password settings

Set ftp login password.

Press **UTILITY** → **Interface** → **FTP Password Setting** to enter the FTP Password Setting interface. You can change the FTP password by entering the Current password, New Password and Confirm password. You can also set the FTP password to the default value “siglent” by clicking the “Reset to Default” button.

For usage of FTP, please refer to [\*Download/Upload Files Using FTP \(LAN\)\*](#).

## 3. GPIB Setting

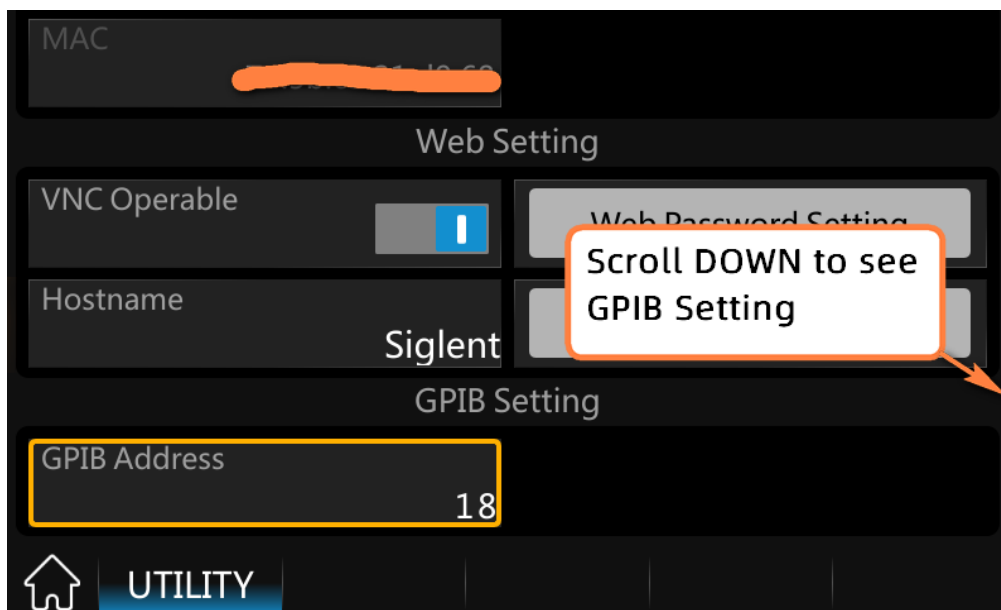

Set the GPIB address from 1 to 30. SSG6000A must use the SIGLENT USB-GPIB interface (optional) connected to the USB Host port located on the rear panel.

Press **UTILITY** → **Interface** → **GPIB Address**, and then press number keys to input value, finally press **ENTER** to make the setup effective.

#### 2.6.1.4 Self Test

##### 1. LCD Test

Press **UTILITY** → **Self Test** → **LCD Test** to enter the screen detection.

SSG6000A cycles through the red, green and blue pixels of the display to verify whether there are dot defects on the screen.

Press **7** to change the color and press **8** or click the screen to exit.

##### 2. Key Test

Press **UTILITY** → **Self Test** → **Key Test** to enter the keyboard test interface. Press the function keys at the front panel one by one and observe whether the corresponding key is checked. If not, an error may have occurred in that key. To exit the test, press **8** three times or click the screen.

### 3. LED Test

Press **UTILITY** → **Self Test** → **LED Test** to enter the LED test interface. Press **7** to light or extinguish the key light of the button **MOD ON/OFF** and **RF ON/OFF**. Press **8** or click the screen to exit the test.

### 4. Board Test

Press **UTILITY** → **Self Test** → **Board Test** to enter the board test interface. Test whether writing and reading are normal for CPLD and FPGA. Click any key to exit.

### 5. Touch Screen Test

Press **UTILITY** → **Self Test** → **Touch Test** to enter the touch screen test interface. Click the marks on the interface to test the touch screen and press **8** to exit the test.

## 2.6.1.5 Shutdown

Press **UTILITY** → **Shutdown** to power off the instrument according to operating hints on the interface.

## 2.6.1.6 Preset

Reset parameter settings according to the type of preset selected.

Press **UTILITY** → **Preset**, to reset the parameters.

## 2.6.1.7 Update

Press **UTILITY** → **Update**, and select the update file. Then click **Recall** to update the

---



---

system software. The progress bar will appear on the screen while updating and the instrument will restart automatically if updates succeed or pop-up prompt box if updates fail.



#### 2.6.1.8 Option



Press **Utility** → **Option**, to enter the option interface. Click the drop-down box under the “Install” to choose the license type that you wish to install. Then click on the text field below the install type and use the touchscreen keypad to enter the license information. Click **Install** to finish the license installing.

If the installations succeed, the prompt message “license was successfully installed” will be pop-up. If not, the prompt message “license was entered incorrectly” will be displayed.

**Note:** The SSG comes with trial time for available options. The remaining number of trial use is displayed for each option at top of the option interface. When the remaining time of a certain function is zero, the function will be disabled. When a license is successfully installed for a certain function, the remaining times will be shown as “—” and the type of the license is permanent, which means users have unrestricted access to the function.

#### 2.6.1.9 Help

Press **UTILITY** → **Help**, to enter help interface and select the help items you need to view. You can jump to the related page by clicking underline texts, return to the help list by clicking the icon , return to the last page by clicking the icon . And after returning to last page, you can return to the original page by

clicking the icon . Click  to search the function you want to view.

### 2.6.1.10 Contact Us

Press **UTILITY** → **Contact Us** to view the contact information for SIGLENT. You can contact us to solve the problems meet in practical use. You can also write to [info@siglent.com](mailto:info@siglent.com) or call your local SIGLENT sales office for support.

### 2.6.2 Save/Recall

Press **UTILITY** → **Save/Recall** to enter file management page. Then you can select file by knob and fold or expand folders by left and right direction keys.

#### 1. View Type

Click **View Type** to change the type of files to show, including “All”, “State” and “Update” .

##### 1) Data file:

- .lsw file: Sweep list data file;
- .uflt file: Flatness correction file;
- .pulstrn file: Pulse train file;
- .dac file: reference oscillator code file of 10M Adjustment function.

##### 2) State file:

- .xml file: State saving file
- .txt file: the log file of power sensor.

##### 3) Update file:

- .CFG file: Configuration update file;
- .ADS file: System update file.

#### 2. New Dir

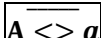
Click **New Dir** to create new folders. Press  to switch the case of letter when entering the name of a new file.

3. Rename

Click **Rename** to rename a file or folder.

4. Delete

Click **Delete** to delete the selected file or folder.

5. Copy

Click **Copy** to copy the selected file or folder.

6. Paste

Click **Paste** to paste the copied file or folder to specified location.

7. Recall

Click **Recall** to load the selected file.

8. Save

Click **Save** to save the file with corresponding type according to the type of data.

## 2.7 Power Sensor

The SSG6000A can be connected to a USB power sensor via the USB Host interface. First connect the USB power sensor to the USB Host connector on the rear panel. If the “Power sensor has been connected!” message pops up on the screen, the signal source has successfully activated the power meter control option, and you can always use the power sensor function.

The power sensors currently supported by the SSG6000A are shown in the following table:

Manufacturer	Model
R&S (Rohde and Schwarz)	<ul style="list-style-type: none"> <li>● NRPxxA series: NRP6A, NRP18A,</li> <li>● NRPxxS series: NRP8S, NRP18S, NRP33S, NRP40S, NRP50S, NRP67S,</li> <li>● NRPxxT series: NRP40T.</li> </ul>
Keysight	<ul style="list-style-type: none"> <li>● U2000 series USB Power Sensor: U2000A, U2001A, U2002A, U2004A, U200B, U2001B, U2000H, U2001H, U2002H.</li> </ul>

### 2.7.1 Power meter setting

The power sensor menu can be accessed in the following ways:

- ◆ Click on POWER SENSOR on the home page.

- ◆ Switch menus by clicking the menu button or swiping in the Frequency, Level, or Sweep menu.

#### 2.7.1.1 Sensor Info

Indicate the type of a connected power sensor. The sensor type is automatically detected.

#### 2.7.1.2 Sensor State

The default is “off”. Activate/deactivate level measurement by the power sensor.

- On: Turn on the power sensor measurement function, and the measurement control refreshes the power sensor measurement value in real time.
- Off: Turn off the power sensor measurement function.

#### 2.7.1.3 Measurement

Indicate the current reading of the sensor.

Select the unit used for result display. You can change the unit for the result display: dBm, dB $\mu$ V, uV, mV, V, nW, uW, mW, W.

#### 2.7.1.4 Level Control

With the Level Control function, you can achieve very stable and accurate RF power for your DUT. With the aid of a downstream control circuit, a CLPC (Closed Loop Power Control), you can detect frequency response characteristics of the components, such as losses due to cables, modules or components and compensate these effects accordingly.

### 2.7.1.5 Statistics

The default is “off”. When activated, statistics indicate the measured mean, maximum, minimum value and the count of each measurement.

- On: Turn on the statistics function. Each statistical parameter is displayed on the parameter bar. Statistical parameters include average, minimum, maximum and count value. Click the “Clear” button to clear all current statistics and start new statistics.
- Off: Turn off statistics. Statistical parameters will be hidden.

### 2.7.1.6 Auto Zero

When the power meter is zeroed, the zero measurement deviation and noise influence can be reduced, and the accuracy of the RF power measurement can be improved.

- Disable: The “Click to perform zeroing” button will be hidden.
- Internal Zeroing: In this way, the power sensor remains connected to the RF signal during the zeroing process. The “Click to perform zeroing” button is displayed.
- External Zeroing: When this mode is selected, the RF signal must be removed from the input port of the power meter before zeroing. Otherwise it will affect the zeroing result. The “Click to perform zeroing” button is displayed.

Press the “Click to perform zeroing” button, and the instrument performs the zero calibration operation of the power meter according to the “zero calibration type” you selected. This feature can be used to reduce the effects of noise and zero offset on the measurement results. And the button name will change from “Click to perform zeroing” to “Zero In Progress...”. After the zero adjustment is completed, the button name will be restored to “Click to perform zeroing”.

**Note:** If the power meter does not have an internal or external zeroing option, the “internal” and “external” in the drop-down box are replaced by the “Enable” option.

#### 2.7.1.7 Measure Frequency

The default is “Auto”. Click the drop-down box to switch the mode.

- Auto: In this mode, the instrument configures the frequency value based on the output frequency of the RF.
- Manual: In this mode, the measurement frequency can be set by the touch screen keyboard or the front panel keypad.

#### 2.7.1.8 Level Offset

The default is “Off”. Click the slide switch to switch the level offset status.

- On: The value can be set by the touch screen keyboard or front panel keypad. The displayed value will be the actual measurement value plus the offset value. This feature makes measurements easier when there are amplifiers or attenuators in the signal chain.
- Off: The display is consistent with the actual reading of the power sensor.

#### 2.7.1.9 Averaging Mode

The default is “Auto”. Click the drop down box to switch the averaging mode.

- Auto: Automatically configure the average number of times based on the current parameters. Fixed noise parameter settings will be automatically hidden.
- Manual: Manually set the average times in Averaging Count.
- Fixed Noise: The power sensor will control the internal noise not to exceed the set value of the fixed noise parameter. Fixed noise parameter settings will

be displayed. It can be set by the touch screen keyboard or the front panel keypad.

**Note:** If the power sensor does not have a “fixed noise” mode, this option will not be displayed in the drop-down box.

### 2.7.1.10 Logging

The default is “Off”. Click the slide switch to switch the logging status.

- On: The signal source will record the measurement values of the power sensor and save these values in a text file.
- Off: The signal source will not record the measurement values.

### 2.7.2 Level Control



As shown above, the sensor measures a proportional power in defined time intervals, derived from a coupler. It considers optionally the given S-parameters and returns the results to the generator. The signal generator compares the measured level with the set value and adjusts its output level accordingly. This allows you to control the external signal level continuously and reliably reach a constant input level to the DUT in real time.

In practice, an RF splitter is needed to split the RF signal. One of them is connected to the DUT and the other is connected to the power meter. The signal source is for



acquisition and compensation. Power compensation can be used to minimize cable losses, the attenuation of passive networks, and the amplification of the signal by a power amplifier and the frequency response of each device in the link as the frequency changes.

**Note:** When the function is turned on, the frequency or level sweep functions will be turned off, and vice versa.

### 2.7.2.1 Level Control State

The default is “Off” .

- On: Turn on the power sensor level control function, and the measurement control refreshes the power sensor measurement value in real time.
- Off: Turn off the power sensor level control function.

### 2.7.2.2 Measurement

Indicate the current reading of the sensor. Select the unit used for result display.

You can change the unit for the results display: dBm, dB $\mu$ V, uV, mV, V, nW, uW, mW, W.

### 2.7.2.3 Target Level

Specify the nominal level expected at the input of the sensor. The signal generator adjusts the output power accordingly, in order to meet the target value at the sensor input, and thus the power required at the DUT.

The value can be set by the touch screen keyboard or the front panel keypad.

#### 2.7.2.4 Limit Level

Set an upper limit for the RF output power to protect your DUT from damage due to high input power. If the input RF signal power exceeds the limit, the set value will not take effect and the source will pop up a warning message.

#### 2.7.2.5 Catch Level

The capture range means that if the power sensor reading is within the effective capture range, it is a valid reading and the RF signal will be adjusted and compensated. If the power sensor reading exceeds this range, the reading will be ignored.

Effective Capture Range = Target Level +/- Catch Range

## 2.8 Shortcut Keys

### 2.8.1 PRESET

Recall the preset setting and restore the signal generator to a specified status.

- Press **UTILITY** → **Settings** → **Preset Type** to select “Default” or “User”.
- Press **PRESET** to load the factory settings listed in the following table or user-defined settings.

Table 2-3 Default setting

Parameter	Default
<b>RF</b>	
RF State	Off
<b>Frequency</b>	
Frequency	40 GHz
Freq Offset	0 Hz
<b>Level</b>	
Level	-120 dBm
Level Offset	0 dB
ALC State	Auto
Flatness	Off
<b>Sweep</b>	
Sweep State	Off
Sweep Mode	Continuous
Direction	Up
Trigger Mode	Auto
Point Trigger	Auto
Trigger Slope	Positive
<b>Step Sweep</b>	
Step Sweep State	On
Start Freq	40 GHz
Stop Freq	40 GHz
Start Level	-120dBm
Stop Level	-120dBm
Sweep Points	11
Dwell Time	30 ms
Sweep Space	Linear
Sweep Shape	Sawtooth
<b>List Sweep</b>	

List Sweep State	Off
<b>ANALOG MOD</b>	
ANALOG MOD State	Off
<b>AM</b>	
AM State	Off
AM Source	Int
AM Shape	Sine
AM Rate	1 kHz
AM Depth	50 %
<b>Pulse</b>	
Pulse State	Off
Pulse Source	Int
Pulse Mode	Single
Pulse Period	10 ms
Pulse Width	2 ms
Double Pulse Delay	4 ms
#2 Width	2 ms
Trigger Out	On
Pulse Trigger	Auto
Trig Delay	140 ns
Trig Slop	Positive
Pulse Polarity	Normal
Pulse Out	Off
Trig Polarity	Normal
Pulse Train	Off
<b>LF Source</b>	
LF State	Off
LF Shape	Sine
LF Frequency	1 kHz
LF Level	500 mV
LF Offset	0 uV
LF Phase	0 deg
<b>LF Sweep</b>	
Sweep State	Off
Start Freq	500 Hz
Stop Freq	1.5 kHz
Center Freq	1 kHz
Freq Span	1 kHz
Sweep Time	1 s
Trigger Mode	Auto
Sweep Shape	Sawtooth

---

Trigger Mode	Linear
Direction	Up

### 2.8.2 Home

Return to the home page.

### 2.8.3 TRIG

When the trigger mode of the sweep is Key, press this key once to trigger a sweep.

When the trigger mode of the pulse is Key, press this key once to start a pulse modulation.

When the trigger mode of the LF sweep is Key, press this key once to trigger a LF sweep.

### 2.8.4 ESC

- Switch the instrument from remote control to manual control.
- Quit the edit mode, if the edit mode is active.
- In dialog boxes that contain an “Esc” button it closes the dialog box.
- Exit the current menu and return to the previous menu.

### 2.8.5 MOD ON/OFF

Enable/disable modulation on the RF output. When enabled, the backlight will light, the MOD icon in the screen status bar will change from gray to blue, and RF output modulation will be activated. Press this button again to disable modulation. When disabled, the backlight is off, all modulation is off, and the MOD icon in the screen status bar changes from blue to gray.

### 2.8.6 RF ON/OFF

Enabled or Disable the RF output. When enabled, the backlight will light, the RF icon in the screen status bar will change from gray to blue, and the RF output will be enabled. Press this button again to disable RF output. When disabled, the backlight is off, RF output is off, and the RF icon in the screen status bar changes from blue to gray.

## Chapter 3 Application Examples

### 3.1 REMOTE vs LOCAL mode

When the signal generator is controlled by a remote computer, the instrument will be in REMOTE mode and the front panel input will be locked.

As shown below, the “REMOTE” icon appears in the status bar, and if you touch the screen or press any key in the front panel, a warning box will appear.

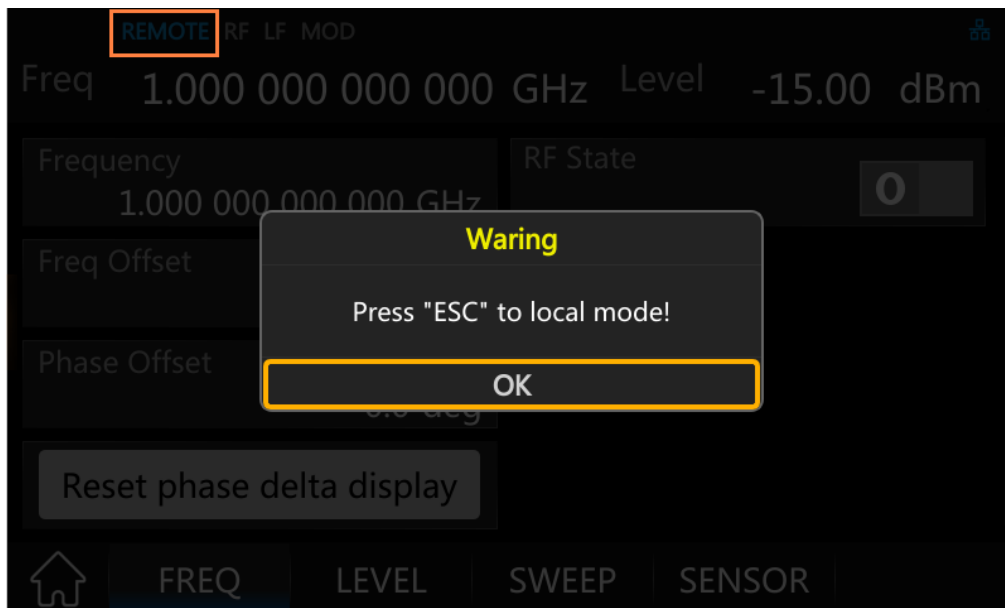

To unlock the front panel, namely, to enter LOCAL mode, there are two ways:

- Press **ESC** in the front panel to quit.
- Send SCPI command “SYSTem:REMOte 0”.

After exiting the REMOTE mode, the “LOCAL” icon will appear in the status bar.

### 3.2 Output RF signal

Output an RF signal with frequency of 3GHz and amplitude of 0dBm from the [RF OUTPUT 50Ω] connector.

1. Restore factory settings
  - a) Press **UTILITY** or the touch screen to set **UTILITY** -> **Settings** -> **Preset Type** -> **Default**.

b) Press **PRESET**, or press **UTILITY** → **Preset**.

## 2. Set the Frequency

Press **FREQ**, and enter the 3GHz with the numeric keypad, or click the frequency on the touch screen to pop up the keypad and input 3GHz.

## 3. Set the Level

Press **LEVEL**, and enter the 0dBm with the numeric keypad, or click the amplitude on the touch screen to pop up the keypad and input 0dBm on the keypad.

## 4. Turn on RF output

Press **RF ON/OFF** or press the **HOME** key back to the main interface, select the RF block, the white square on the left of ON to enable RF output. When enabled, the **RF ON/OFF** key backlight turns green and the RF state in the status bar changes to blue.

At this time, the **[RF OUTPUT 50 Ω]** connector outputs an RF signal with frequency of 3 GHz and amplitude of 0 dBm.

# 3.3 Correcting 10MHz Reference

Users can correct the internal 10MHz reference signal using the 10MHz adjustment function combined with a frequency counter.

Connect the **[10MHz OUT]** connector of the SSG to a frequency counter.

## 1. Restore factory settings

a) Press **UTILITY** or the touch screen to set **UTILITY** → **Settings** → **Preset Type** → **Default**.



- 
- b) Press **PRESET**, or press **UTILITY** -> **Preset**.
2. Set the code of reference OCXO
- a) Press **UTILITY** or the touch screen to set **UTILITY** -> **Settings** -> **10M Adjustment**  
 -> , enter the “Ref Osc setting” .
- b) Press **10M Adjustment**, the switch will toggle to the open state, at which point the OCXO will use the value in the **Ref Osc Code** as the code of the OCXO. If the reference calibration switch is off, the OCXO will use the default code.
- c) Press the **Ref Osc Code**, a small keyboard will pop up, enter the code.
3. Correcting 10MHz Reference
- a) According to the frequency measured by the frequency meter, if it is lower than 10MHz, increase the **Ref Osc Code**, otherwise decrease the **Ref Osc Code**. Repeatedly configure the **Ref Osc Code** until the 10MHz reference signal output by the OCXO meets the accuracy requirements.

### 3.4 Correcting Line Loss

Users can correct line loss using the Flatness function combined with a power meter. Connect the **[RF OUTPUT 50Ω]** connector of the SSG to the cable under test, and connect the end of the cable to a power meter. Plug the power meter into the USB port of the SSG and wait for the power meter connection to complete.

4. Restore factory settings
- c) Press **UTILITY** or the touch screen to set **UTILITY** -> **Settings** -> **Preset Type** -> **Default**.
- d) Press **PRESET**, or press **UTILITY** -> **Preset**.
5. Set the Frequency & Level
- d) Press **FREQ**, and enter the 1GHz with the numeric keypad, or click the frequency
-

on the touch screen to pop up the keypad to input 1GHz.

- e) Press **LEVEL**, and enter the 0dBm with the numeric keypad, or click the amplitude on the touch screen to pop up the keypad to input 0dBm on the keypad.
6. Set the frequency of flatness calibration
  - b) Press **LEVEL** → **Flatness** → , select the **Fill Type** as “Manual Step” ;
  - c) Set the **Start Freq** to 4GHz, **Stop Freq** to 5GHz, **Points** to 11;
7. Perform amplitude calibration
  - a) Click “**Fill Flatness with Sensor**” button and a “Collecting” dialog will pop up.

After the data collection is finished, it will automatically return to the flatness list page and give the corrected amplitude correction value for each frequency.

## 3.5 Output a modulated signal

In this section, we will show how to enable modulation by configuring the SSG6000A to output an AM modulated signal with the following characteristics: Carrier frequency is 1GHz, the carrier amplitude is -10dBm, the AM modulation depth is 80%, the modulation frequency is 10 kHz, and the modulation waveform is a sine wave.

1. Restore factory settings
  - a) Press **UTILITY** or the touch screen to set **System** → **Setting** → **Preset Type** → **Default**.
  - b) Press **PRESET** or reset the system settings to perform reset operations.
2. Set the carrier frequency & amplitude
  - a) Press **FREQ** and enter 1GHz with the numeric keypad, or click the frequency input box on the touch screen to pop up the keypad to input 1GHz on the keypad.
  - b) Press **LEVEL**, type -10 dBm with the digital keyboard, or click on the amplitude input box on the touch screen, pop up the keyboard, and type - 10dBm on the

keyboard;

3. Set the AM modulation parameters

Press the **MOD** or click the ANALOG MOD function block on the touchscreen to enter the amplitude modulation parameter setting interface.

- a) Set the modulation waveform to be a sine wave;
- b) Set the modulation depth to 80%;
- c) Set the modulation frequency to be 10 kHz;
- d) Set the AM state open;

4. Enable the RF modulation output

- a) Press **MOD ON/OFF** and then press **RF ON/OFF**. The backlights of **MOD ON/OFF** and **RF ON/OFF** will be illuminated. RF and MOD labels in the status bar will change from gray to blue.

At this time, the signal on the **[RF OUTPUT 50 Ω]** connector will match the settings configured above.

## 3.6 Output a pulse train

A pulse train is a user-defined sequence of high and low RF levels with specific time durations for each part. In this example, we will show how to configure the RF source to output the following pulse train:

Serial number	Positive pulse width	Negative pulse width	Repetitions
1	10ms	30ms	1
2	20ms	20ms	2

1. Restore factory settings

- a) Press **UTILITY** or touch **Preset Type**→ **Default**.
  - b) Press **PRESET** or reset the system settings to perform the reset operation.
2. Install the pulse train option
- a) Activate the pulse train generator option.
3. Edit pulse list
- a) Press **MOD** or select ANALOG MOD from the Home page. You can swipe left or right or press **MOD** repeatedly to reach the Pulse Mode screen. Set Pulse Mode to Train, and the Pulse Train menu will appear.
  - b) Click  in Pulse Train menu to enter settings, set the positive width of first pulse to 10ms, the negative width to 30ms, and the count to 1.
  - c) Click the “+” on the left to add one line, set the positive pulse width to 20ms, the negative pulse width to 20ms, and the count to 2.
  - d) After clicking, you can click **Diagram** on the bottom to see the schematic diagram of the pulse train as follows.

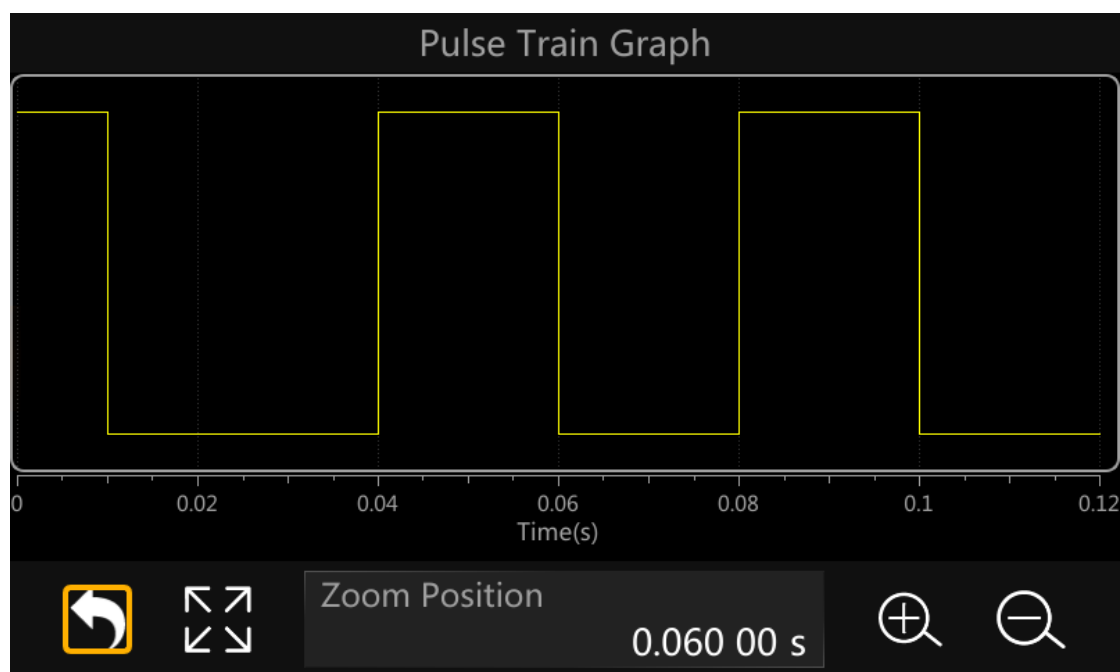

4. Set the **Pulse State** to on.
5. Enable the RF modulation output
  - a) Press **MOD ON/OFF** and then press **RF ON/OFF**. The backlights of **MOD ON/OFF** and **RF ON/OFF** will be illuminated. RF and MOD labels in the status bar will change from gray to blue.

At this time, the signal on the [RF OUTPUT 50  $\Omega$ ] connector will match the settings as configured above.

## 3.7 Download/Upload Files Using FTP (LAN)

SSG6000A users can download local files to the PC or upload files to the signal generator by using FTP directly in the file browser of the PC over a local area network (LAN).

The following procedure describes how to download or upload files using FTP on a PC connected to your SSG6000A through a LAN:

1. Set LAN parameters of the signal generator. Ensure that the IP address can be pinged through.
2. Open the file browser of the PC. At the address bar of the file browser, enter: *ftp://<IP address>*, such as *ftp://10.11.xx.xxx/*, and then press Enter.

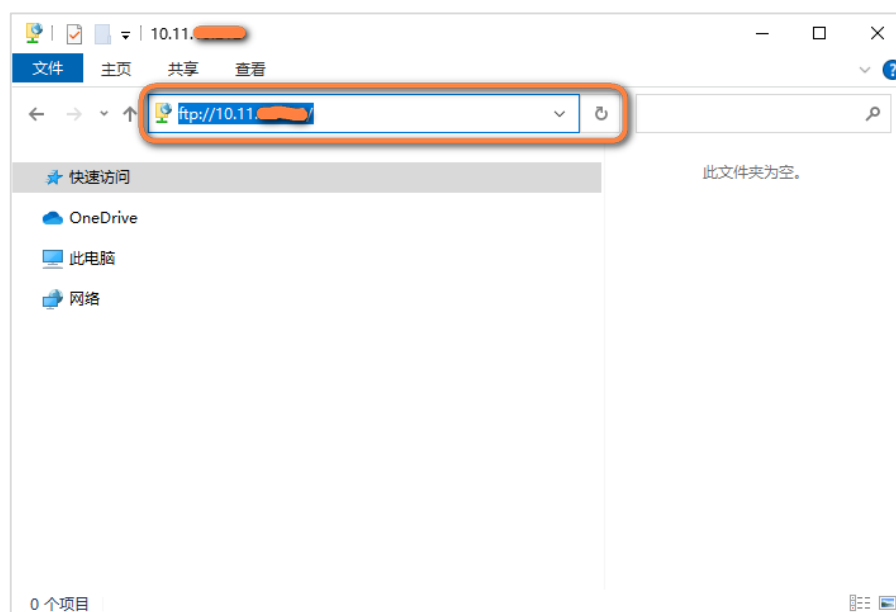

3. A prompt dialog box will pop up in the file browser. You should check the FTP

Server address and enter the FTP password.

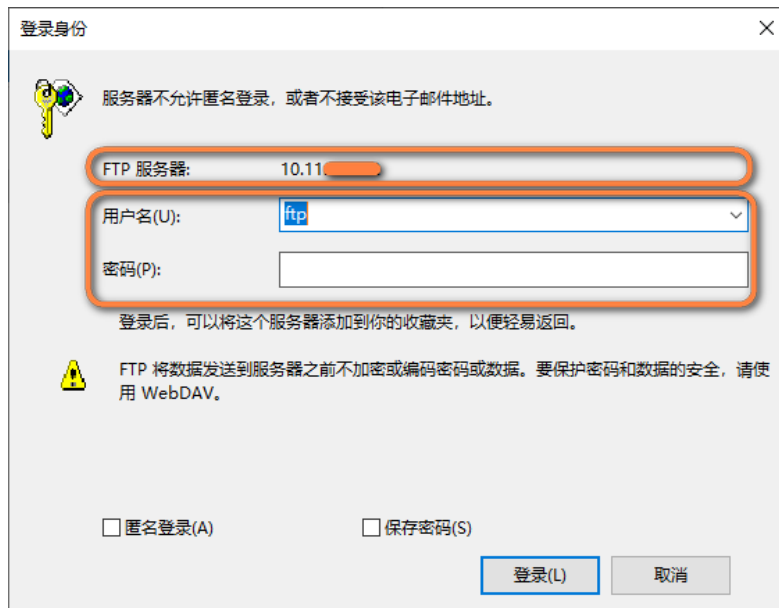

4. Before proceeding to step 3, you should set the FTP password on the signal generator. Click **UTILITY** -> **System** -> **Interface** -> **FTP Password Setting**, to enter the FTP Password Setting interface.

Notice: put your mouse or finger in the middle of the screen and drag UP and DOWN. You will see the FTP Password Setting button appear.

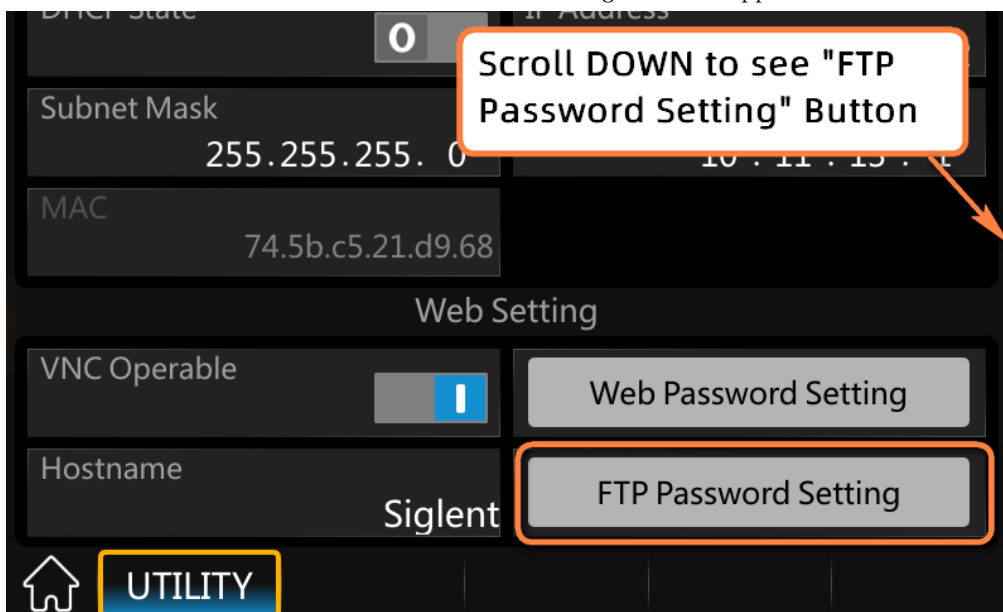

You can change the FTP password by entering the Current password, New Password and Confirm password. You can also set the FTP password to the default value "siglent" by clicking the "Reset to Default" button.

The ftp user name is ftp and cannot be set.

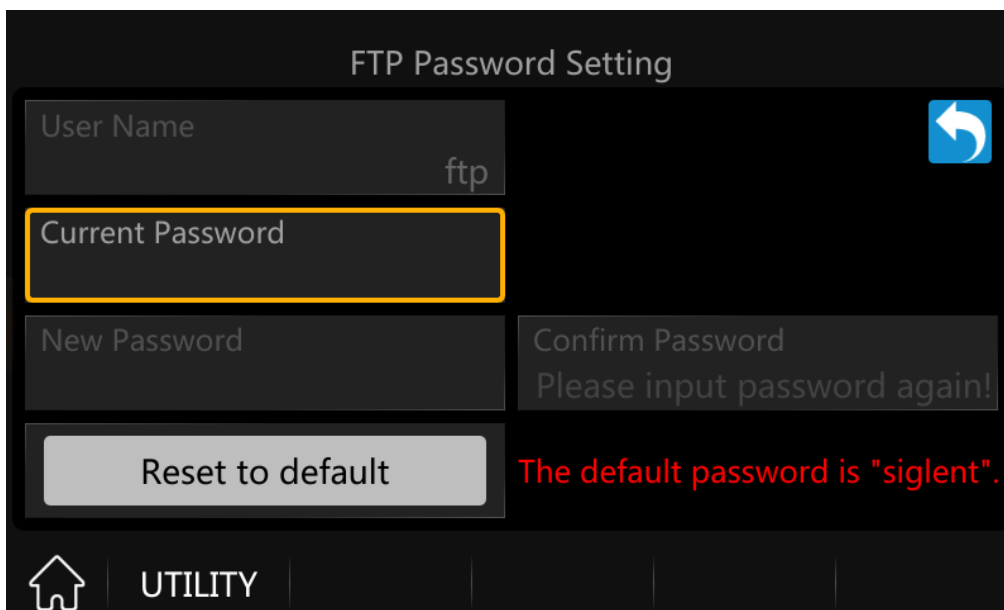

5. Go back to Step 3. In the file browser dialog box, enter the FTP password. Click “Log In” and you can access to the “Local” folder of the signal generator. You can download files from the Local folder to your PC, or copy files from your PC to the Local folder of the signal generator.

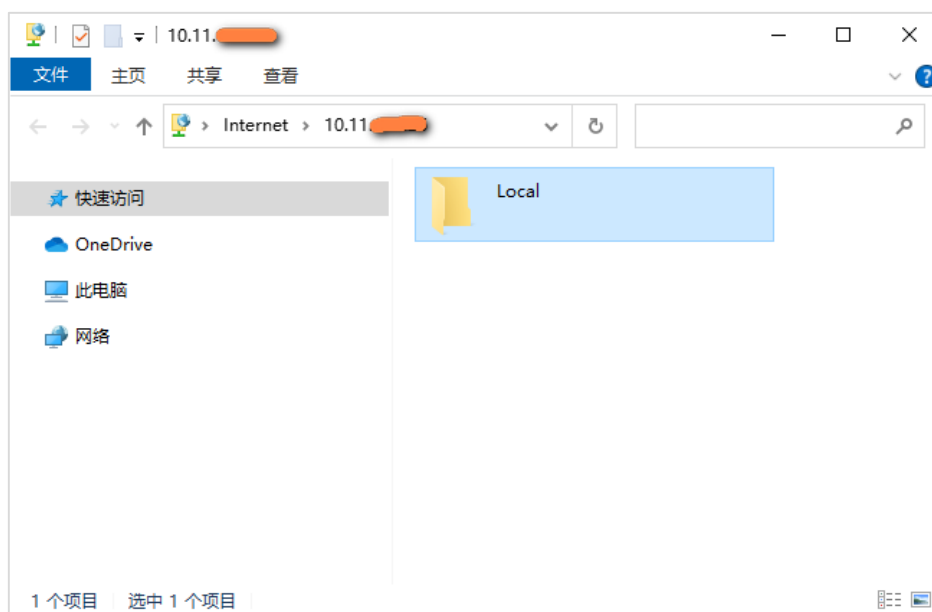

## Chapter 4 Programming Overview

The SSG6000A Signal Generator features a LAN, USB Device, and SIGLENT GPIB—USB module interfaces. By using a computer with these interfaces, and a suitable programming language (Python, C+, .NET, etc., and NI-VISA software), users can remotely control the signal generator using standard SCPI (Standard Commands for Programmable Instruments) commands. The SSG6000A Programming Guide features more details on the specific commands.

This chapter introduces how to build communication between the signal generator and a controller computer with these interfaces.

### 4.1 Remote Operation

The SSG provides both the USB and LAN connection which allows you to set up a remote operation environment with a controller computer. A controller computer could be a personal computer (PC) or a minicomputer. Some intelligent instruments also function as controllers.

#### 4.1.1 Connecting via the USB Device port

Refer to the following steps to finish the connection via USB-Device:

1. For standard installations, you can use NI-VISA on your PC for the VXI driver.  
If you wish to control the instrument without NI-VISA, use sockets or telnet.
2. Connect the SSG USB Device port to a PC with a USB A-B cable.
3. Switch on the SSG.





Figure 4-1 USB Device

The SSG will be detected automatically as a new USB hardware.

### 4.1.2 Connecting via the LAN port

Refer to the following steps to finish the connection via LAN:

1. Install NI-VISA on your PC for VXI driver. Or without NI-VISA, using socket or telnet in your PC' s Operating System.
2. Connect the SSG to PC or the local area network with a LAN cable.
3. Switch on the SSG.



Figure 4-2 LAN

4. Press button on the front panel **System** → Interface → LAN to enter the LAN Configure function menu.
5. Select the IP Configure between Static and DHCP
  - ◆ DHCP: the DHCP server in the current network will assign the network parameters automatically (IP address, subnet mask, gate way) for the SSG.
  - ◆ Static: you can set the IP address, subnet mask, gate way manually. Press Apply.

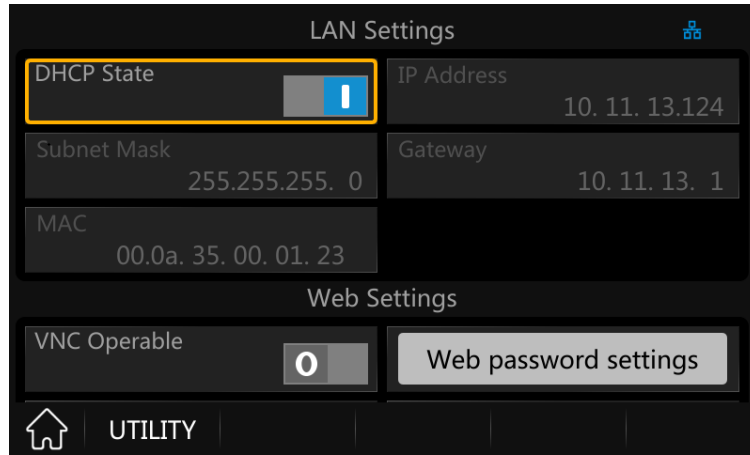

Figure 4-3 LAN Configure

The SSG will be detected automatically or manually as a new LAN point.

### 4.1.3 GPIB: Connecting via the USB-Host port

Refer to the following steps to finish the connection via USB:

1. Install NI-VISA on your PC for GPIB driver.
2. Connect the SSG USB Host port to a PC's GPIB card port, with SIGLENT USB-GPIB adaptor.
3. Switch on the SSG.



Figure 4-4 SIGLENT USB-GPIB Adaptor

4. Press button on the front panel **System** → Interface → GPIB to enter the GPIB number.

The SSG will be detected automatically as a new GPIB point.

## 4.2 Build Communications

### 4.2.1 Build Communications Using VISA

NI-VISA includes a Run-Time Engine version and a Full version. The Run-Time Engine version provides NI device drivers such as USB-TMC, VXI, GPIB, etc. The full version includes the Run-Time Engine and a software tool named NI MAX that provides a user interface to control the device.

You can get NI-VISA full version from:

<http://www.ni.com/download/>.

After download you can follow the steps below to install it:

1. Double click the visa\_full.exe, dialog shown as below:

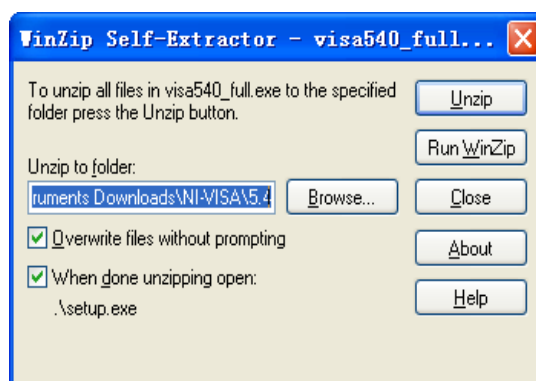

2. Click Unzip, the installation process will automatically launch after unzipping files. If your computer needs to install .NET Framework 4, its setup process will auto start.



3. The NI-VISA installing dialog is shown above. Click Next to start the

installation process.

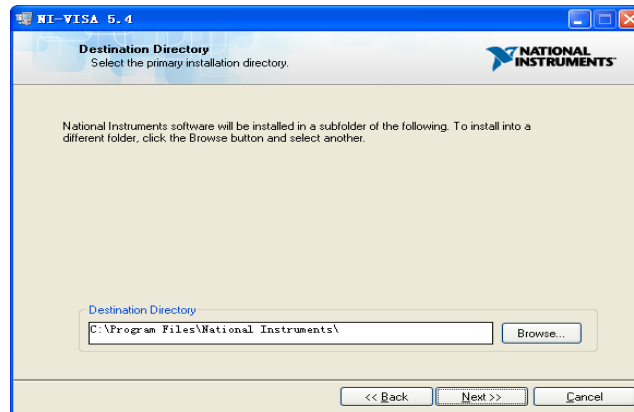

4. Set the install path, default path is “C:\Program Files\National Instruments\”, you can change it. Click Next, dialog shown as above.

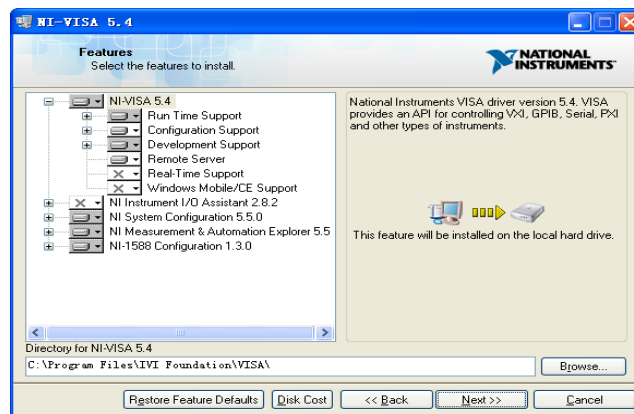

5. Click Next twice, in the License Agreement dialog, select the “I accept the above 2 License Agreement(s).”, and click Next, dialog shown as below:

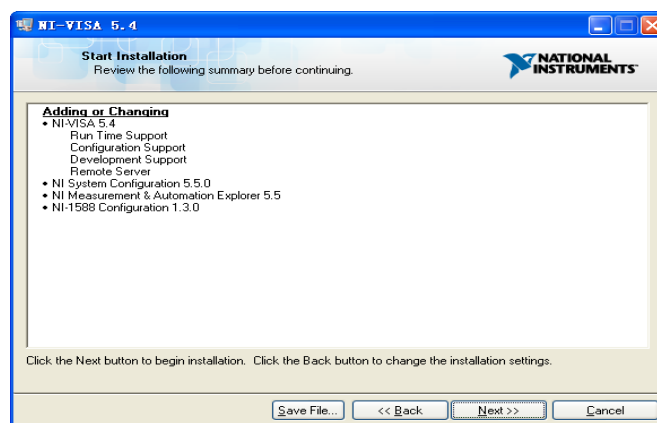

6. Click Next to run installation.

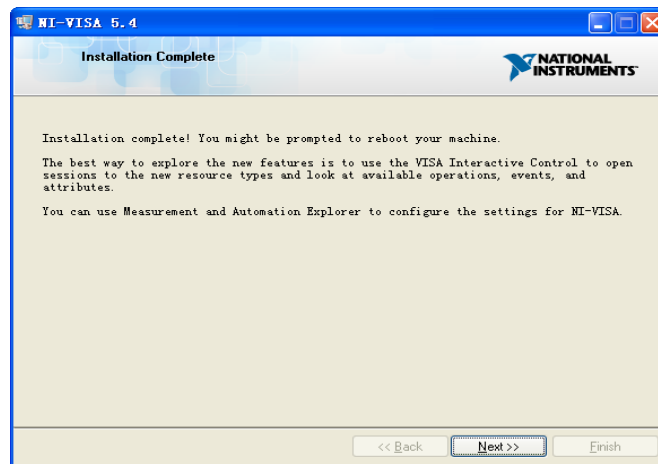

Now the installation is complete, reboot your PC.

## 4.2.2 Build Communications Using Sockets/Telnet

Through the LAN interface, VXI-11, Sockets and Telnet protocols can be used to communicate with the SSG. VXI-11 is provided in NI-VISA, while Sockets and Telnet are commonly included in the operating system (OS) of many computers.

Socket LAN is a method used to communicate with the signal generator over the LAN interface using the Transmission Control Protocol/Internet Protocol (TCP/IP). A socket is a fundamental technology used for computer networking and allows applications to communicate using standard mechanisms built into network hardware and operating systems. The method accesses a port on the signal generator from which bidirectional communication with a network computer can be established.

Before you can use sockets LAN, you must select the signal generator's sockets port number to use:

- **Standard mode:** Available on port 5025. Use this port for programming.
- **Telnet mode:** The telnet SCPI service is available on port 5024.

## 4.3 Remote Control Capabilities

### 4.3.1 User-defined Programming

Users can use SCPI commands to program and control the signal generator. For details, refer to the introductions in “Programming Guide”.

### 4.3.2 Send SCPI Commands via NI MAX

Users can control the signal generator remotely by sending SCPI commands via NI-MAX software. NI\_MAX is National Instruments Measurement and Automation Explorer. It is an executable program that enables easy communication to troubleshoot issues with instrumentation.

#### 4.3.2.1 Using USB

Run NI MAX software.

1. Click “Device and interface” at the upper left corner of the software;
2. Find the “USBTMC” device symbol



3. Click “Open VISA Test Panel” option button, then the following interface will appear.

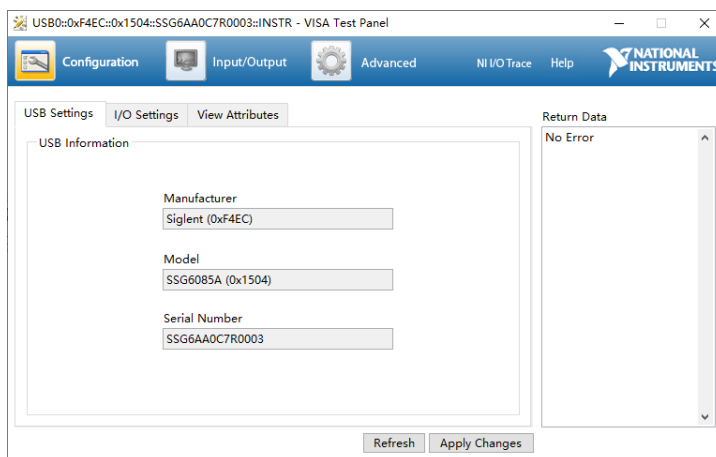

- Click the “Input/Output” option button and click the “Query” option button in order to view the operation information.

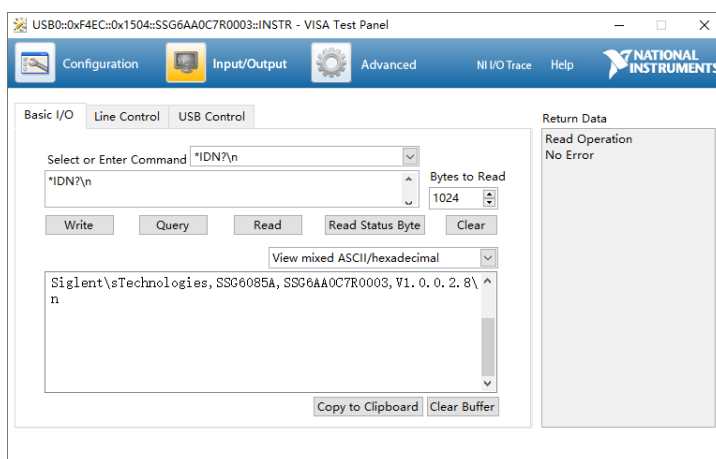

**Note:** The “\*IDN?” command (known as the Identification Query) returns the instrument manufacturer, instrument model, serial number, and other identification information.

#### 4.3.2.2 Using LAN

Select “Add Network Device”, and select “VISA TCP/IP Resource” as shown:

Run NI MAX software.

- Click “Device and interface” at the upper left corner of the software;
- Find the “Network Devices” symbol, click “Add Network Devices” ;

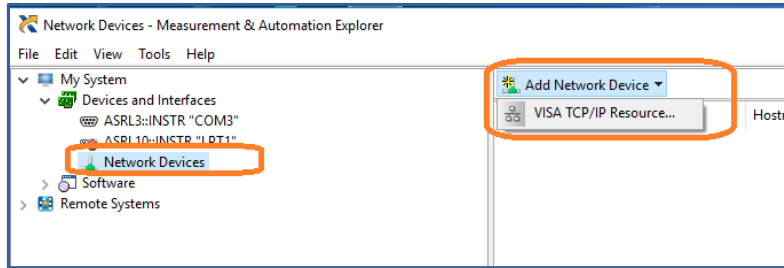

3. Select Manual Entry of LAN instrument, select next, and enter the IP address as shown. Click Finish to establish the connection:

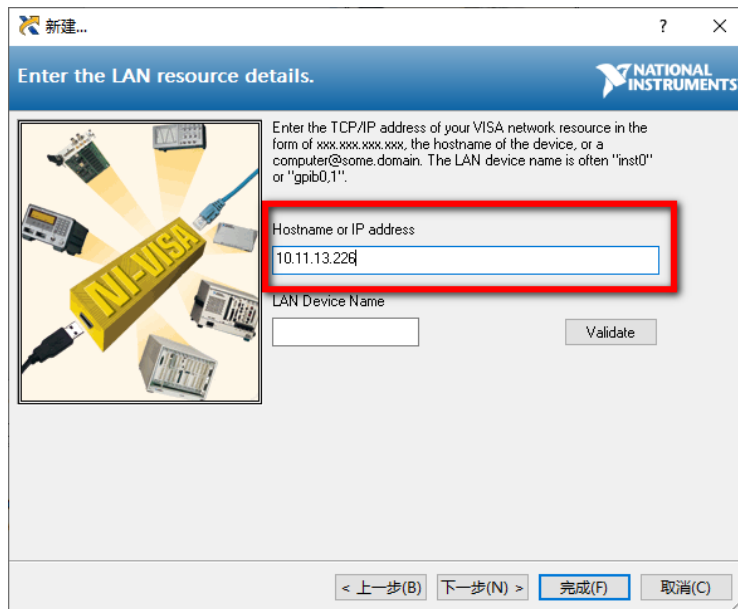
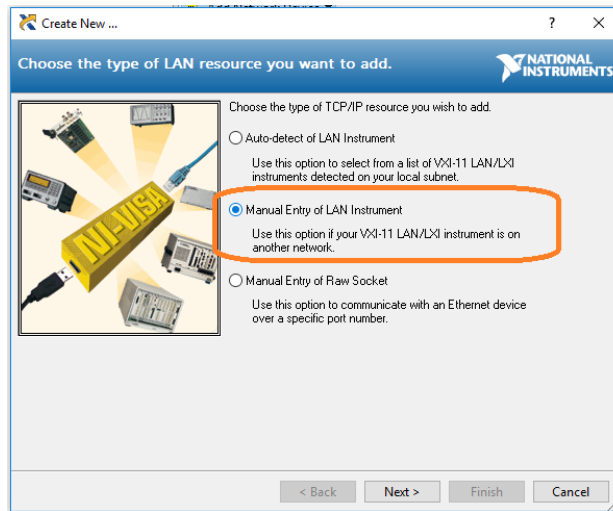

4. After a brief scan, the connection should be shown under Network Devices:



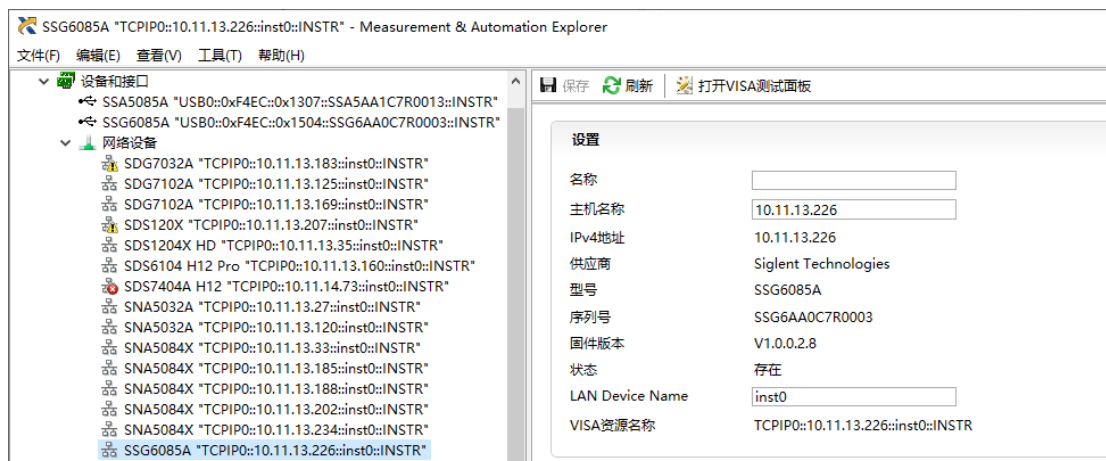

5. Click “Open VISA Test Panel” option button:

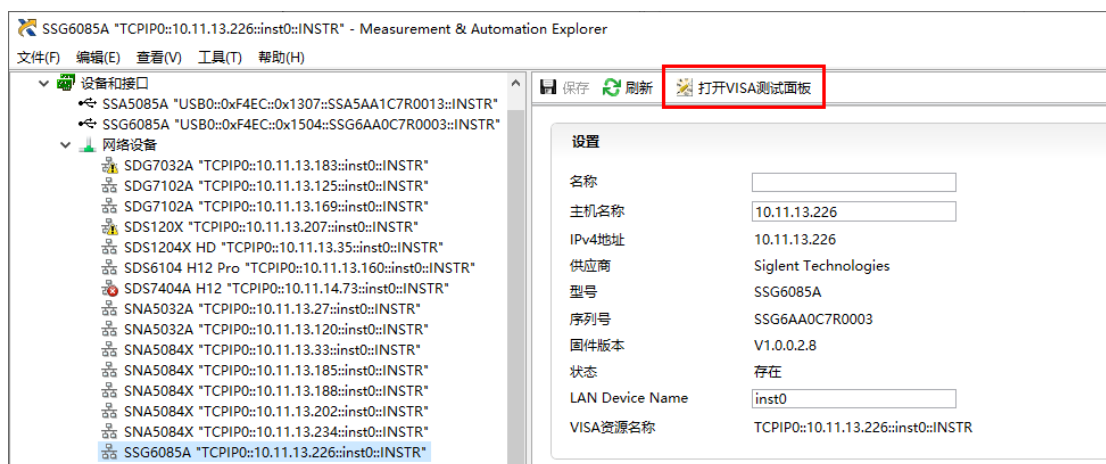

6. Click “Input/Output” option button and click “Query” option button. If everything is OK, you will see the Read operation information returned as shown below.

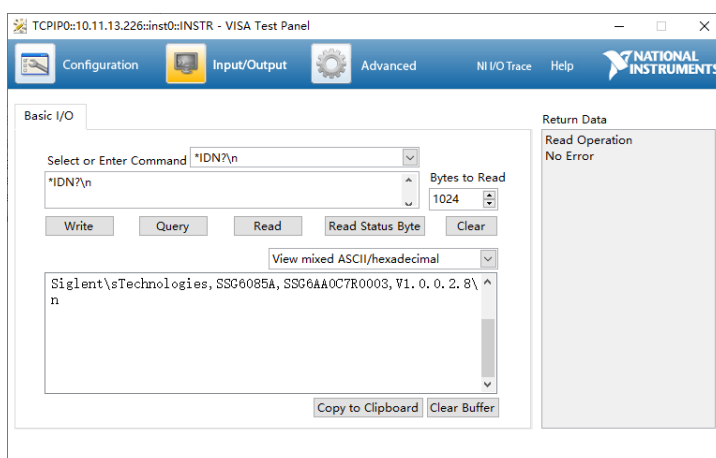

### 4.3.1 Web Control

With the new embedded web server, users can control the SSG6000A through LAN from a web browser on PC or mobile terminals. This provides wonderful remote controlling and monitoring capabilities.

# Chapter 5 Troubleshooting

## 5.1 General Inspection

### 1. Inspect the shipping container

Keep the damaged shipping container or cushioning material until the contents of the shipment have been completely checked and the instrument has passed both electrical and mechanical tests.

The consigner or carrier will be responsible for damages to the instrument resulting from shipment. **SIGLENT** will not provide free maintenance or replacement.

### 2. Inspect the instrument

If the instrument is found to be damaged, defective or fails in electrical or mechanical tests, please contact **SIGLENT**.

### 3. Check the accessories

Please check the accessories according to the packing list. If the accessories are incomplete or damaged, please contact your **SIGLENT** sales representative.

## 5.2 Troubleshooting

Before calling **SIGLENT**, or returning an SSG for service, perform the quick checks listed below. This check may eliminate the problem.

If the problem remains still, please contact **SIGLENT** and provide your device information of the SSG (Get method: **UTILITY**→**System Info**).

### **1. The SSG' s screen is still dark (no display) after power on:**

(1) Check whether the fan is running:

- If yes, the connection of the internal screen cable may be loose.
- If not, the instrument has failed to start up and please refer to step (2).

(2) Check the power:

- Check whether the power supply has been connected correctly and the power switch has been turned on.
- Check whether the power fuse is burned. If a new fuse needs to be installed, please use the specified fuse type/rating.

### **2. The key is unresponsive or gives a wrong response:**

(1) Press all the keys at the front panel to check if all of them are normal after power on.

(2) Press **Utility** → **Self Test** → **Key Test** to check if all the keys are working properly.

(3) If a key is not working, the numeric keyboard connection might be loose or the numeric keyboard is broken.

Do not disassemble the instrument by yourself and contact **SIGLENT**.

### **3. Correct setting but incorrect waveform output**

(1) No RF output

—Check that the signal cable is securely connected to the corresponding [RF OUTPUT 50 Ω] port.

—Check the cable for damage.

—Check if the RF button backlight is lit. If not lit, press this button to light it and the user interface status bar RF flag turns blue. The RF output is now turned on correctly.

—Check if the signal output amplitude is too small, and adjust the output amplitude

appropriately.

(2) No modulation on the RF output

—Check that the signal cable is securely connected to the corresponding [RF OUTPUT 50 Ω] port.

—Check the cable for damage.

—Check that both the MOD and RF button backlights are lit and that the modulation switch needs to be turned on.

—Check if the modulation parameters are appropriate and modulate the modulation parameters appropriately.

—If an external modulation source is used, make sure that the external source is connected correctly and has an output and should work within the range established by the source.

#### **4. Sweep is abnormal:**

(1) Scanning stagnation

The user interface frequency zone/amplitude zone displays a scan progress bar indicating that a scan operation is in progress. If there is stagnation, check the points.

—Open at least one scan type: Select Frequency, Amplitude, or Frequency & Amplitude according to the SWEEP scan type status.

—If the single scan mode is enabled, a single scan is performed when the single software meets the trigger condition.

—If the scan trigger mode is not automatic trigger, press SWEEP trigger mode to automatically trigger to determine if the scan trigger is missing and the scan is blocked.

—If the point trigger mode is not automatic trigger, it is automatically triggered by the SWEEP trigger mode to determine if the point trigger is missing and the scan

is blocked.

–Determine if the dwell time setting is too large or too small for the scan to be visible.

–Make sure at least two points are set in the step scan or list scan.

(2) In the list or step scan, the amplitude does not change

–Verify that the scan type is set to Amplitude or Frequency & Amplitude.

–If the current scan type is set to Frequency, the amplitude value does not change.

#### **5. USB device cannot be recognized:**

(1) Check if the USB device is connected to other instruments or the computer can work normally.

(2) Confirm the flash type U disk device used. This instrument does not support the hard disk type U disk device.

(3) After restarting the instrument, insert the USB flash drive to check.

(4) If you are unable to use the USB flash drive normally, please contact.

#### **6. Inaccurate measurement results or insufficient accuracy:**

Users can obtain detailed descriptions of technical indicators from the back of this manual to calculate system errors and check measurement results and accuracy issues.

To achieve the performance metrics listed in this manual, you need:

(1) Check if the RF signal source is within the calibration period (1 year).

(2) Verify that the RF signal source has been warmed up for at least 30 minutes before testing.

(3) Check that the performance of the test equipment used meets the requirements.

(4) Ensure that the test equipment used is within the calibration cycle.

(5) Check if the test equipment used is under the working conditions required by its manual.

(6) Check if all connections are tightened.

**7. Pop-up Message:**

The instrument may display prompt messages, error messages or state messages according to the current working status. These messages are displayed to help you to use the instrument correctly and are not instrument failures.

## Chapter 6 Service and Support

### 6.1 Service Summary

**SIGLENT** warrants that the products that it manufactures and sells will be free from defects in materials and workmanship for a period of three years (accessories for a period of one year) from the date of shipment from an authorized Siglent distributor. If the product proves defective within the respective period, **SIGLENT** will provide repair or replacement as described in the complete warranty statement.

To arrange for service or obtain a copy of the complete warranty statement, please contact your nearest Siglent sales and service office. Except as provided in this summary or the applicable warranty statement, **SIGLENT** makes no warranty of any kind, express or implied, including without limitation the implied warranties of merchantability and fitness for a particular purpose. In no event shall **SIGLENT** be liable for indirect, special or consequential damages.



## 6.2 Contact Us

### China:

**SIGLENT TECHNOLOGIES CO., LTD.**

Add: Bldg. No. 4 & No. 5, Antongda Industrial Zone, 3rd Liuxian Road, Bao'an District,  
Shenzhen, 518101, China.

Tel: + 86 755 3661 7876

Fax: + 86 755 3359 1582

Email: sales@siglent.com;

[Website: http://www.siglent.com/ens/](http://www.siglent.com/ens/)

### USA:

**SIGLENT Technologies America, Inc.**

6557 Cochran Rd Solon, Ohio 44139

Tel: 440-398-5800

Toll Free: 877-515-5551

Fax: 440-399-1211

Email: info@siglent.com

[Website: www.siglentamerica.com](http://www.siglentamerica.com)

### Europe:

**SIGLENT TECHNOLOGIES EUROPE GmbH**

ADD: Liebigstrasse 2-20, Gebaeude 14, 22113 Hamburg Germany

Tel: +49(0)-819-95946

Fax: +49(0)-819-95947

Email: [info-eu@siglent.com](mailto:info-eu@siglent.com)

[Website: www.siglenteu.com](http://www.siglenteu.com)